

CV630-IP
HD/UHD camera
(PTZ Video Camera)

User Manual - English

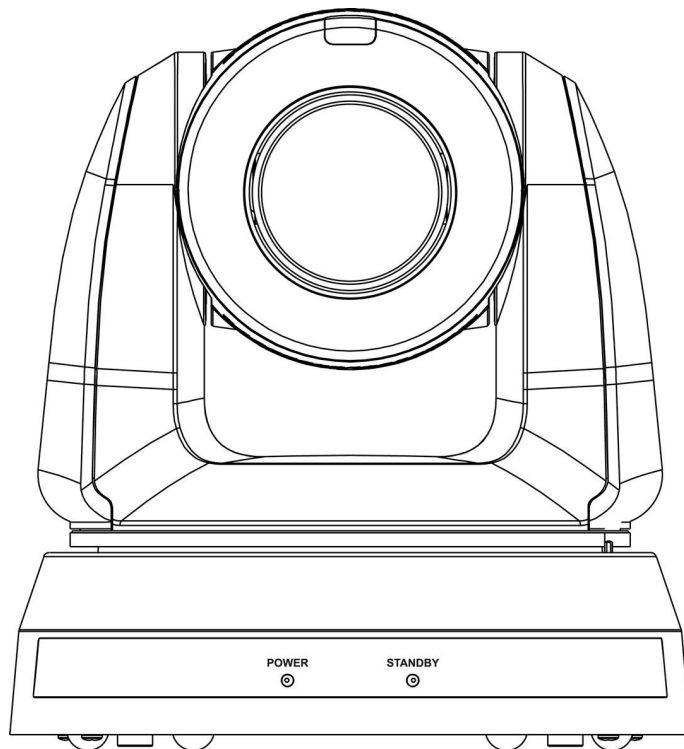

Table of Contents

Copyright Information	2	
Chapter 1	Safety Instructions	3
Chapter 2	Package Contents	5
Chapter 3	Function Introduction	6
3.1	I/O functions Introduction	6
3.2	Description of LED indicator	7
3.3	Tally Indicator Light Function Description	7
Chapter 4	Instruction for installation	8
4.1	Preparation before installation	8
4.2	Instruction for installation	8
4.3	Connecting devices	15
Chapter 5	Remote Control and Setting Menu	20
5.1	Functions of remote control	20
5.2	Setting Menu	21
Chapter 6	Network Function Settings Description	28
6.1	Connecting Camera to Network	28
6.2	Web Page Function Description	30
Chapter 7	DIP Switch Setting	41
Chapter 8	Troubleshooting	42

Copyright Information

Copyright 2020 Marshall Electronics, Inc. All rights reserved.

Copying, reproducing or transmitting this file is not allowed if a license is not provided by Marshall Electronics, Inc., unless copying this file is for the purpose of backup after purchasing this product.

In order to keep improving the product, Marshall Electronics, Inc. hereby reserves the right to make changes to product specifications without prior notice. The information in this file is subject to change without prior notice.

To fully explain or describe how this product should be used, this manual may refer to names of other products or companies without any intention of infringement.

Disclaimer of warranties: Marshall Electronics, Inc. is neither responsible for any possible technological, editorial errors or omissions, nor responsible for any incidental or related damages arising from providing this file, using, or operating this product.

Chapter 1 Safety Instructions

Always follow these safety instructions when using the product:

1 Operation

- 1.1 Please use the product in the recommended operating environment.
- 1.2 Do not place the product in tilted position.
- 1.3 Do not place the product on an unstable trolley, stand or table.
- 1.4 Do not use this product near water or source of heat.
- 1.5 Use attachments only as recommended.
- 1.6 Use the type of power source indicated on the product. If you are not sure of the type of power available, consult your distributor or local electricity company for advice.
- 1.7 Always take the following precautions when handling the plug. Failure to do so may result in sparks or fire:
 - Ensure the plug is free of dust before inserting it into a socket.
 - Ensure that the plug is inserted into the socket securely.
- 1.8 Do not overload wall sockets, extension cords or multi-way plug boards to avoid potential risks.
- 1.9 Do not block the slots and openings in the case of the product. They provide ventilation and prevent the product from overheating.
- 1.10 Except as specifically instructed in this User Manual, do not open or remove covers, otherwise it may expose you to electric shock and other hazards. Refer all servicing to licensed service personnel.
- 1.11 Unplug the product from the wall outlet and refer servicing to licensed service personnel when the following situations happen:
 - If the power cords are damaged or frayed.
 - If liquid is spilled into the product or the product has been exposed to rain or water.

2 Installation

- 2.1 For security considerations, please make sure the standard hanging rack you bought is in line with UL or CE safety approbations and installed by technician personnel approved by agents.

3 Storage

- 3.1 Do not place the product where the cord can be stepped on as this may result in fraying or damage to the lead or the plug.
- 3.2 Never push objects of any kind through cabinet slots. Never allow liquid of any kind to spill into the product.
- 3.3 Unplug this product during thunderstorms or if it is not going to be used for an extended period.
- 3.4 Do not place this product or accessories on top of vibrating equipment or heated objects.

4 Cleaning



- 4.1 Unplug all the cables before cleaning. Use a damp cloth for cleaning. Do not use liquid or aerosol cleaners.

5 Remote control (if the accessories are equipped with remote control)

- 5.1 Using an incorrect battery type in the remote control may result in breakdown. Follow local instructions on how to dispose of used batteries.

■ **Precautions**

Warning: To reduce the risk of fire or electric shock, do not expose this appliance to rain or moisture. If Camera will not be used for an extended time, unplug it from the power socket.

	
<p>Caution: To reduce the risk of electric shock, do not remove cover (or back). No user-serviceable parts inside. Refer servicing to licensed service personnel.</p>	
	<p>This symbol indicates that this appliance may contain dangerous voltage which could cause electric shock.</p>
	<p>This symbol indicates that there are important operating and maintenance instructions in this User Manual with this appliance.</p>

■ **FCC Warning**

This Camera has been tested and found to comply with the limits for a Class A digital device, pursuant to Article 15-J of FCC Rules. These limits are designed to provide reasonable protection against harmful interference in a commercial installation.

This digital apparatus does not exceed the Class A limits for radio noise emissions from digital apparatus as set out in the interference-causing equipment standard entitled "Digital Apparatus," ICES-003 of Industry Canada.

Cet appareil numérique respecte les limites de bruits radioélectriques applicables aux appareils numériques de Classe A prescrites dans la norme sur le matériel brouilleur : "Appareils Numériques," NMB-003 édictée par l'Industrie.

■ **EN55032 (CE Radiation) Warning**

Operation of this equipment in a residential environment could cause radio interference.

Chapter 2 Package Contents

CV630-IP

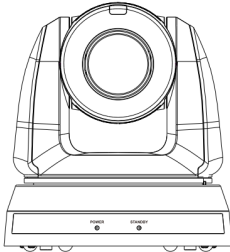

Remote Control



Power Cord

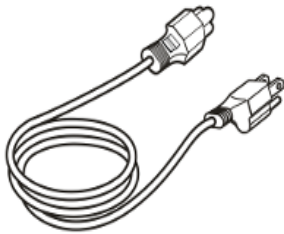

Appearance may vary depending on country/region

Power Adapter

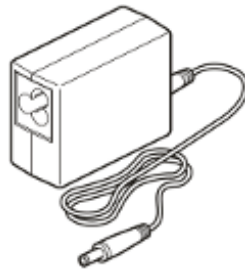

RS-422 Connector

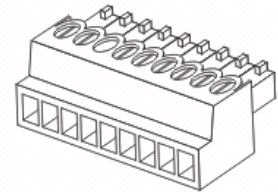

Metal Plate A

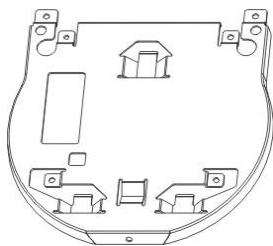

Metal Plate B

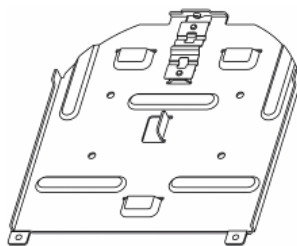

M3 Screws

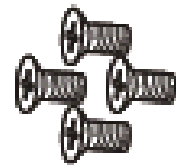

Silver x8 / Black x2

Chapter 3 Function Introduction

3.1 I/O functions Introduction

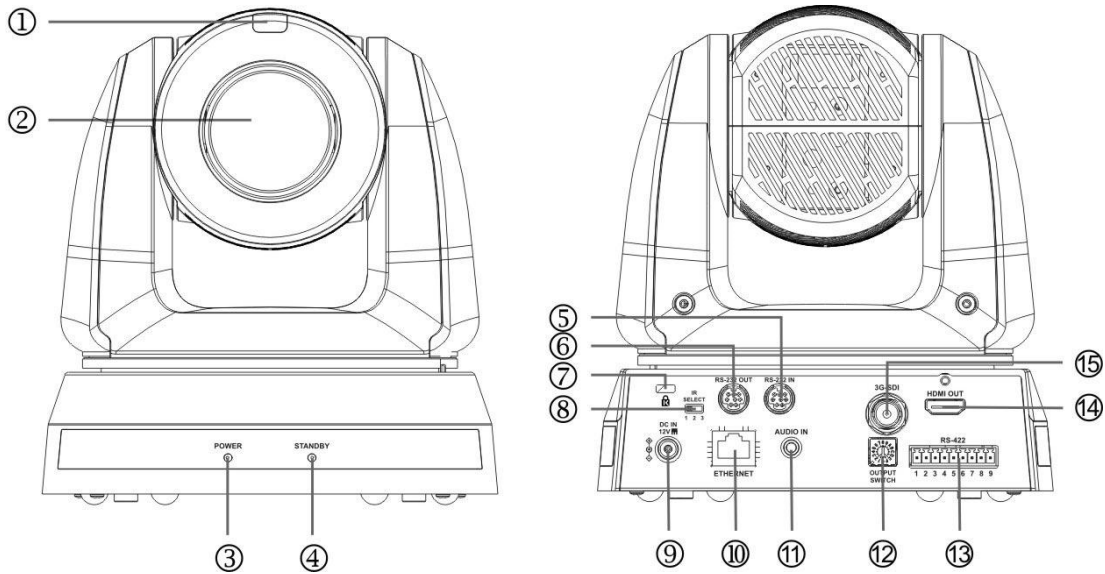

NO.	Item	Function Descriptions
1.	Tally indicator light	Displays the tally light status of the camera
2.	Camera lens	30x HD/UHD camera lens
3.	Power LED indicator	Displays the status of the camera
4.	Standby LED indicator	Displays the status of the camera
5.	RS-232 input	RS-232 input port, up to 7 cameras can be connected in a serial connection
6.	RS-232 output	RS-232 output port, up to 7 cameras can be connected in a serial connection
7.	Kensington lock hole	Lock hole of safety lock
8.	IR SELECT	The remote-control ID setting is set to match and control the specific corresponding Camera (up to three cameras)
9.	DC 12 V power Port	DC power supply connecting port
10.	Ethernet port	Network cable port supports routers or hubs of PoE+ (IEEE 802.3at) with power supply
11.	Audio input	Supports Line/Mic In
12.	OUTPUT Switch	Adjust the resolution setting. The default is 1080p/59.94
13.	RS-422 Port	RS-422 connecting port; up to 7 cameras can be connected in a serial connection
14.	HDMI output	HDMI output (Audio output supported)
15.	3G-SDI output	3G/HD-SDI output (Audio output supported)

3.2 Description of LED indicator

Status	Power	Standby
Startup in progress (initialization)	Green light	Orange light
In use	Green light	No indicator
In standby mode	No indicator	Orange light

3.3 Tally Indicator Light Function Description

3.3.1 The tally indicator light function may be enabled through the control of RS-232 command. The setting method is as follows:

Tally Mode: 8x 01 7E 01 0A 01 0p FF

p = 0: OFF

p = 4: Red light (half-brightness)

p = 5: Red light (full-brightness)

p = 6: Green light (full-brightness)

p = 7: Orange light (full-brightness)

Chapter 4 Instruction for installation

4.1 Preparation before installation

Installation and setup of CV630-IP cameras requires special skills. To install by yourself, please follow necessary steps, ensure steady and secure mounting of the device, and pay attention to your safety to avoid any accidents, drops, or damage.

- 4.1.1 Ensure the safety of the installation environment. Please do not install the device on unstable ceiling fixtures or in places where the device would be in danger of falling.
- 4.1.2 Please check whether accessories in the box are complete. Please contact the Marshall Electronics immediately for any shortages or missing items, and make sure to keep the accessories in the box if not used.
- 4.1.3 Please choose a proper place for installation of camera in advance. Please determine an installation spot according to the following requirements
 - Confirm the position of target objects to be captured.
 - Confirm camera position based on light, and proper distance from light sources.

4.2 Instruction for installation

4.2.1 I would like to install camera on the desk

4.2.1.1 Precautions for installation

- ◆ Please install camera only on flat desk surfaces
- ◆ Do not grab or carry the camera by the camera head
- ◆ Do not rotate the camera head by hand, improper rotation may result in breakage of PT motors or gears of the camera

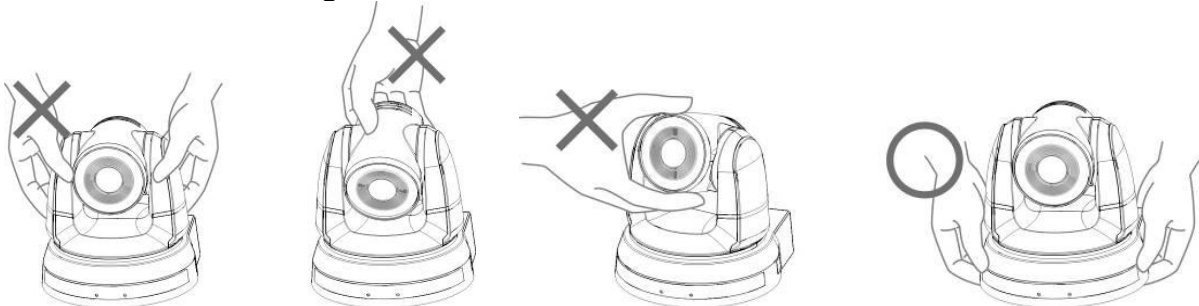

4.2.1.2 Installation steps

1. Please adjust DIP switch to desired resolution and framerate prior to installation. Please refer to [Chapter 7 DIP Switch Setting](#) for the relevant descriptions on DIP switch settings.
2. Place the camera only on flat desk surfaces to ensure integrity of normal vertical and horizontal axis of operation

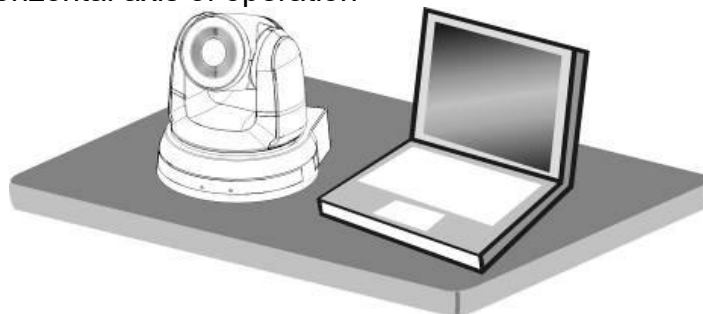

4.2.2 I would like to install the camera on the ceiling

4.2.2.1 Prepare for the parts and equipment required before the installation

1. Accessories in the box (metal plates A, B, M3 screw silver x 8, black x 2)
2. Set screws for locking camera on ceiling mounted hanger x 4
3. Drill, screwdriver, and ladder

4.2.2.2 Camera Size

L x W x H : 174 x 186.1 x 189.7 mm

Weight: 2.0 Kg

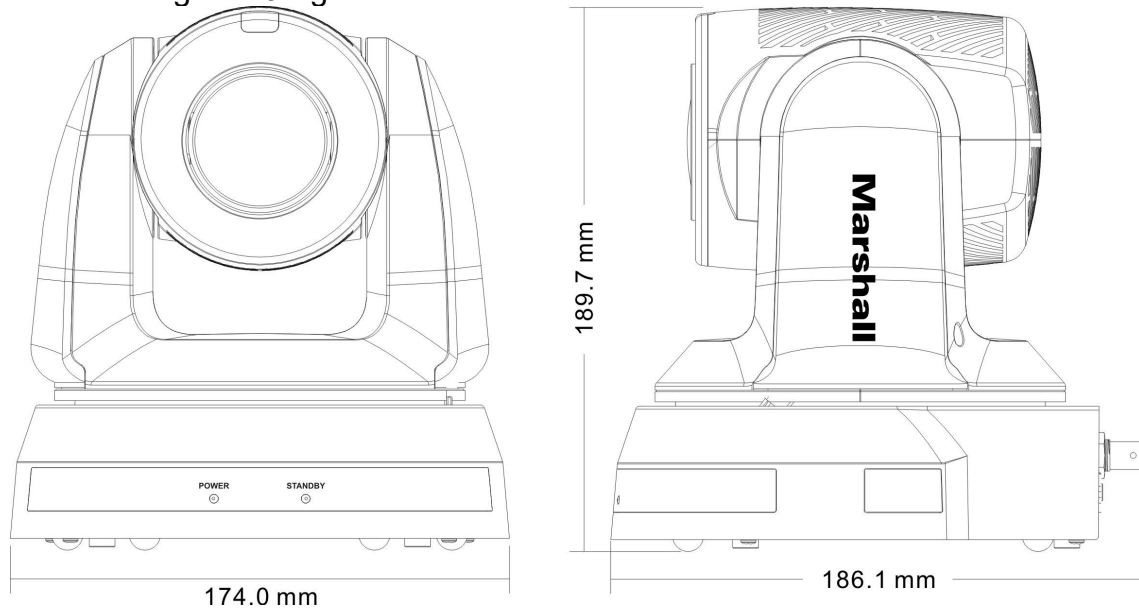

4.2.2.3 Max. rotation dimension of camera

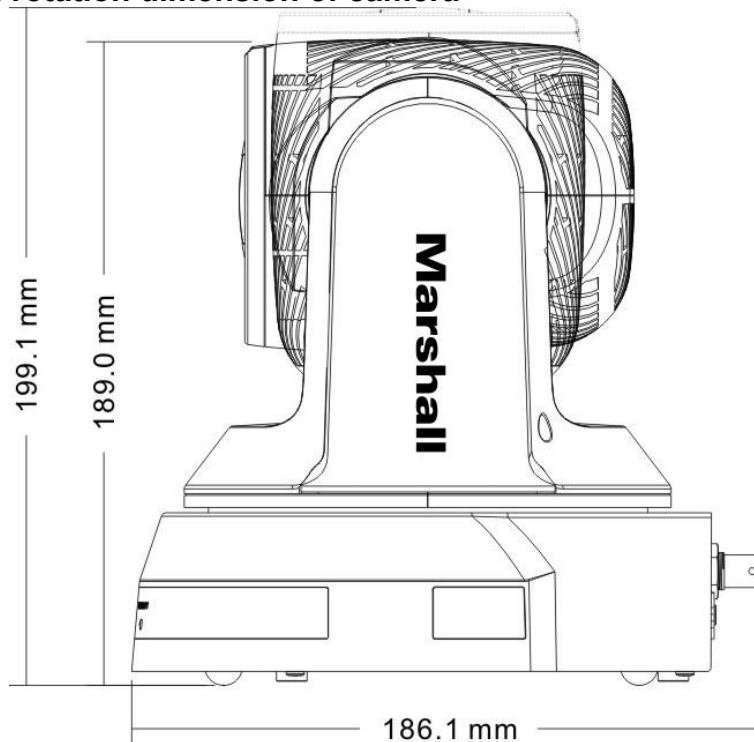

4.2.2.4 Size Diagram

1. Bottom of camera base

The camera can be mounted on a 1/4", -20 UNC PTZ tripod deck by using the lock holes on the bottom for the tripod

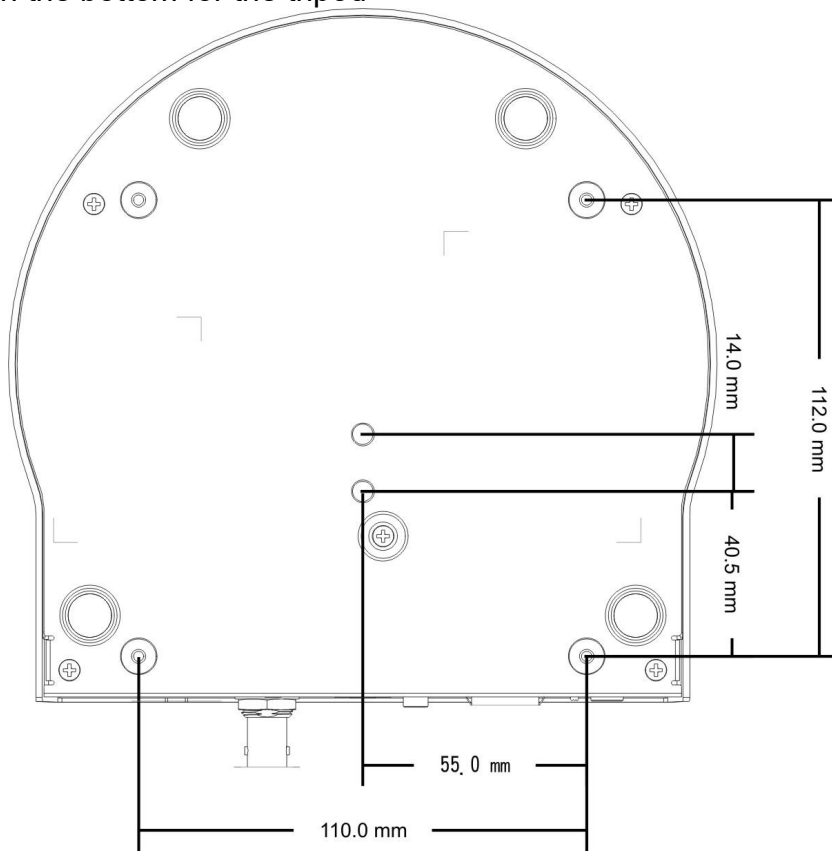

1. Metal Plate size diagram
 - Metal plate B - ceiling side

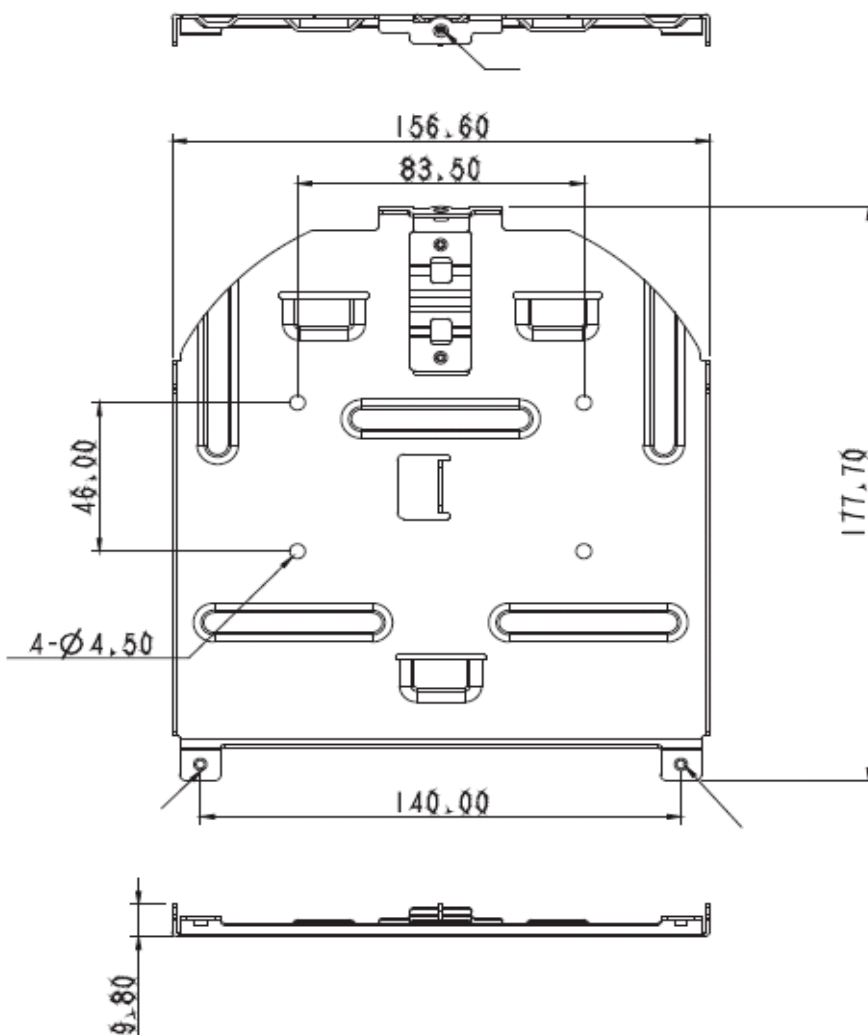
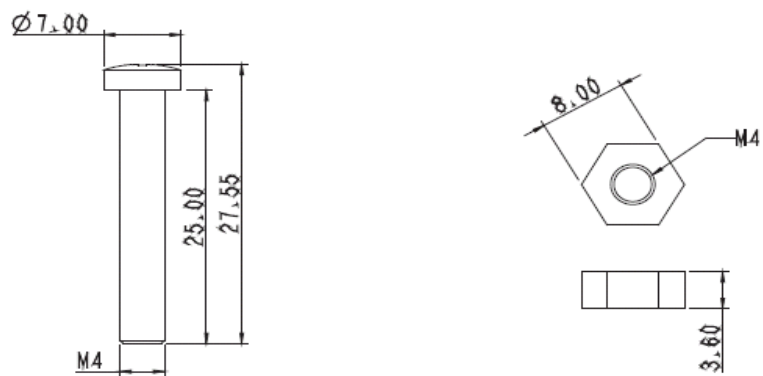

■ Metal plate A – camera base side

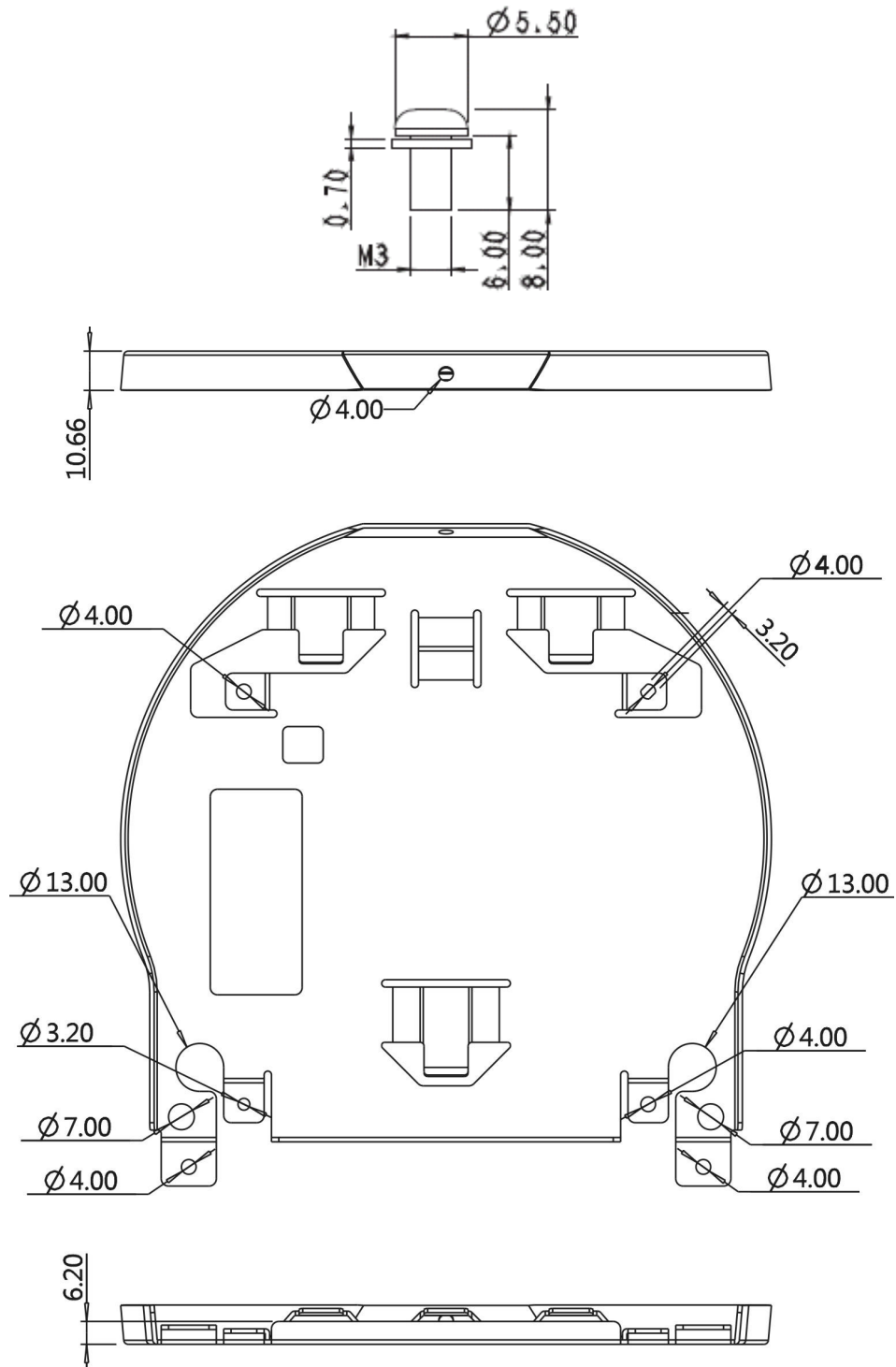

4.2.2.5 Precautions for installation

1. Prior to installation, please confirm the orientation of the camera relative to the object to be captured to ensure Horizontal and Vertical integrity axis.
2. It is recommended for camera be set at a distance of one (1) meter or more from the object to be captured. Please adjust for a best distance according to the magnification of the lens

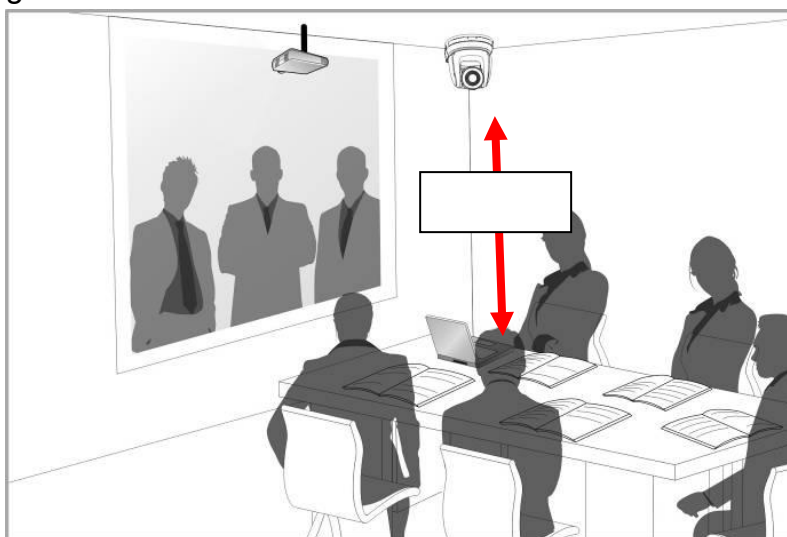

3. The camera (including metal plates) weights approximately 2.5 kg. If it is to be installed on the ceiling, please use the hanger that has obtained UL security approval to prevent the camera from coming loose and falling.
4. Please check that camera is securely installed on a regular basis.

4.2.2.6 Installation steps

1. Please set desired resolution and framerate on Output Switch dial. Please refer to [Chapter 7 DIP Switch Setting](#) for the relevant descriptions on DIP switch settings.
2. Fix the metal plate A on the machine base with 4 M3 silver screws

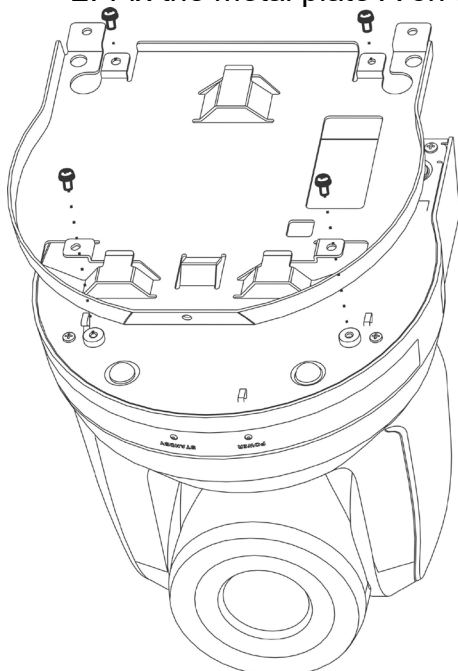

3. Lock the metal plate B on ceiling mounted hanger
- ※ Caution: (1) Please use the hanger with UL security approval
(2) Please make hole for connecting and running wires to the camera

4. Combine the metal plate A and the metal plate B
 - (1) Push the metal plate A up to the ceiling and then to the right to latch the metal plate B into place.
 - (2) And then secure with 2 x M3 silver screws and 1 x M3 black screw

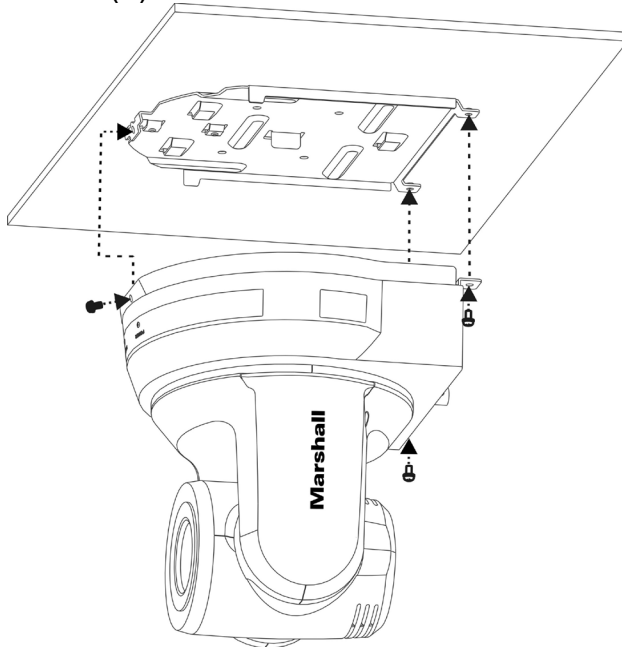

4.2.2.7 How to remove

1. Remove the connected cables and wires from the camera
2. Uninstall the camera attached to ceiling, loosen the three screws that fix the metal plates A and B and push to the left to remove the camera

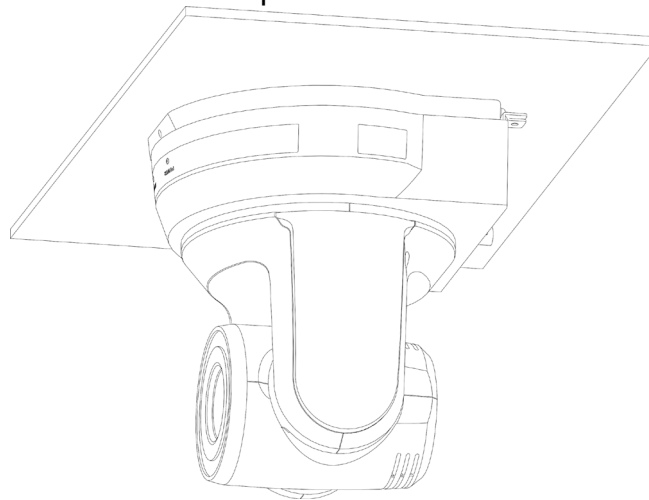

3. Then remove the screws on the hanger and the camera

4.3 Connecting devices

4.3.1 Connecting to PC (video conference)

3G/HD-SDI supports the audio output of 48 KHz only

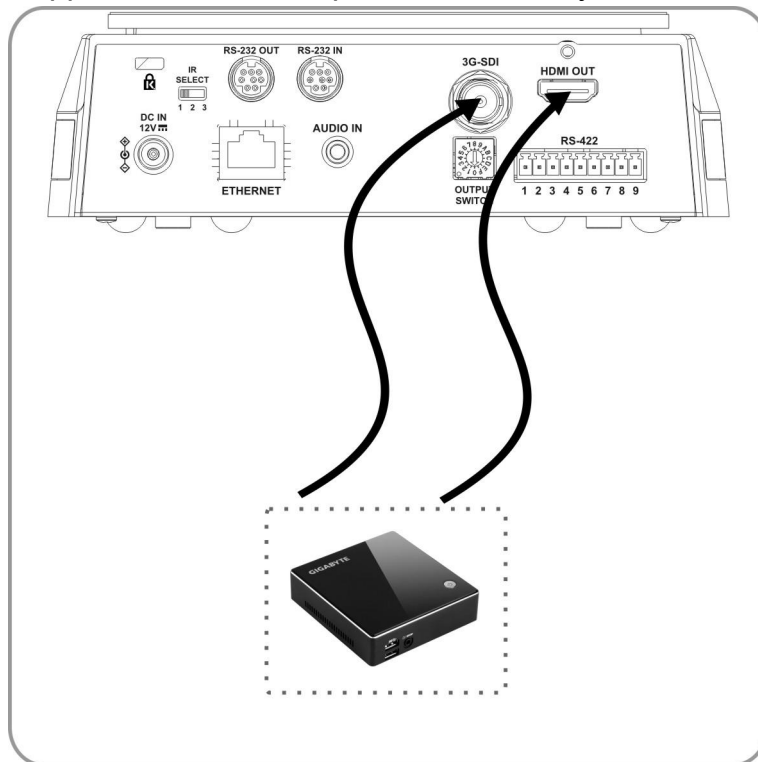

4.3.2 Connecting to an HDTV/computer monitor via HDMI

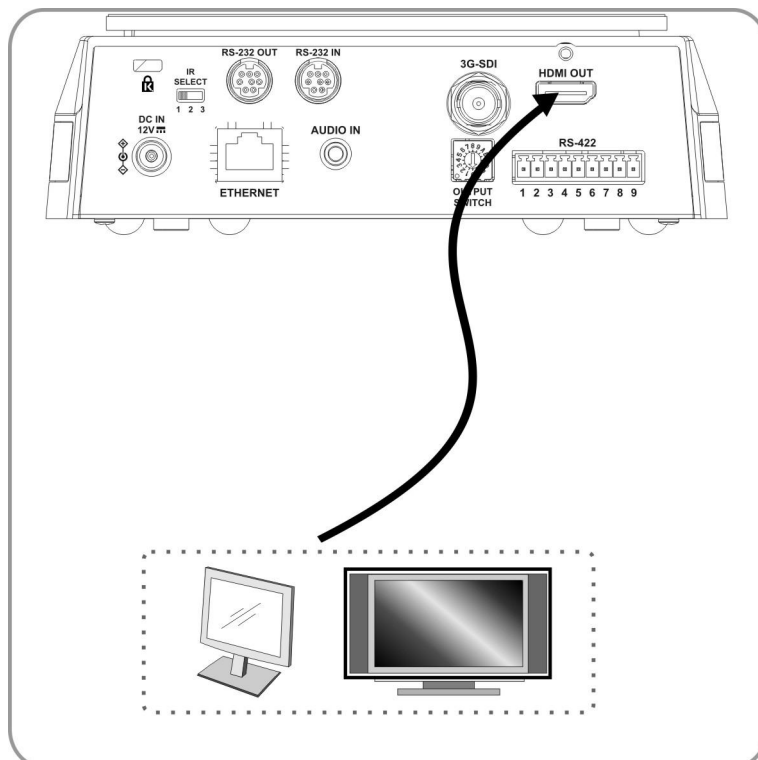

4.3.3 Connecting to Internet

For details of web page setup and description, please refer to [Chapter 6 Network Function Settings Description](#)

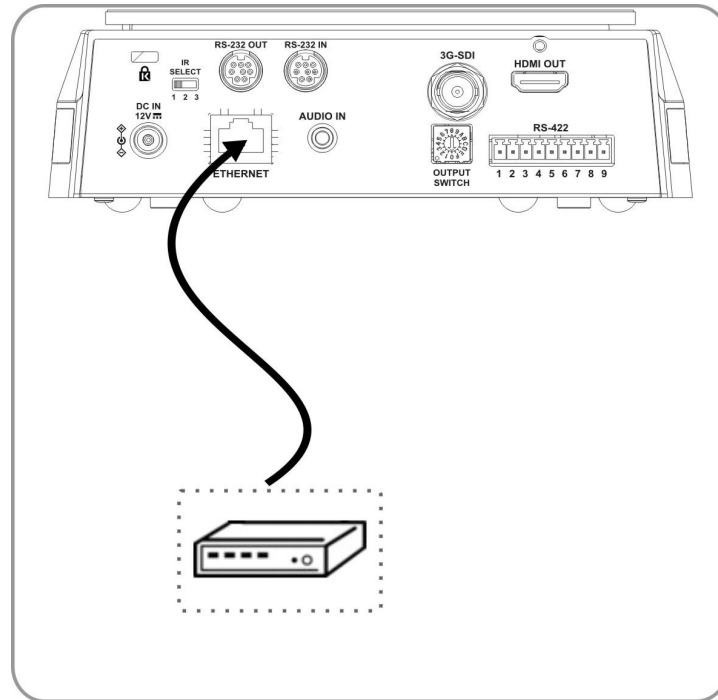

4.3.4 Connecting AUDIO IN

Set the [Audio In] in the OSD to reflect the input device (mic or line level)

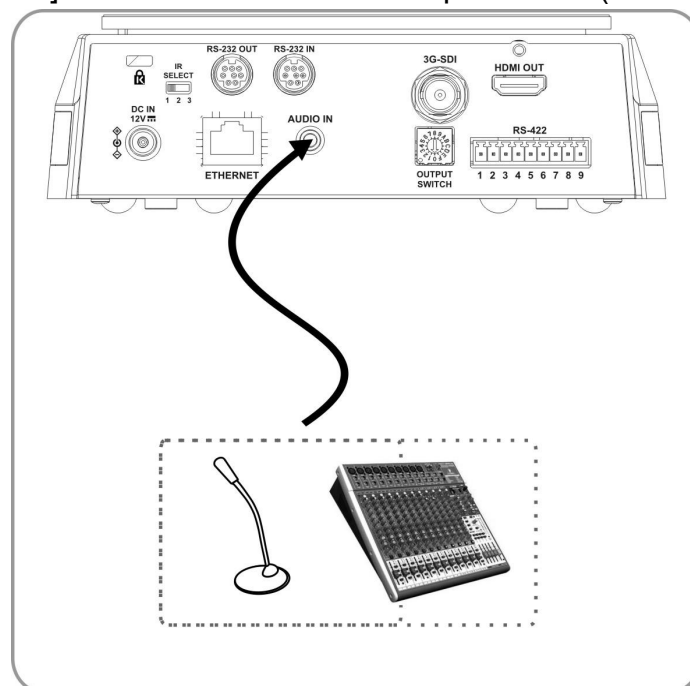

4.3.5 Connecting RS-232

Up to 7 Marshall PTZ cameras can be connected with RS232 daisy chain

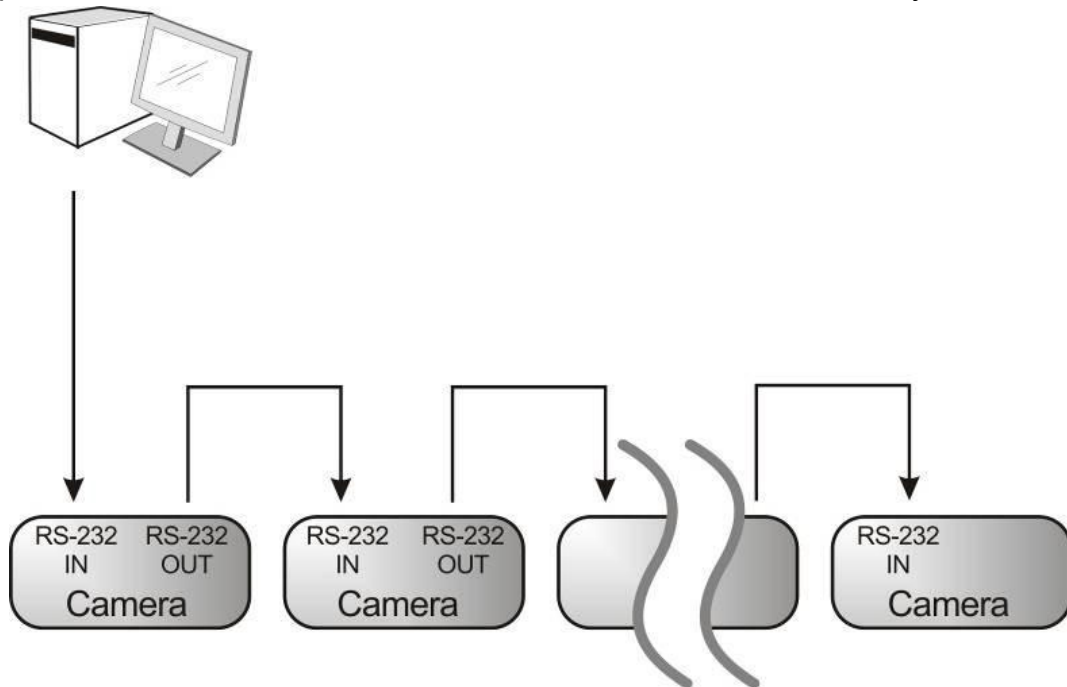

■ RS-232 pins definition instructions

▼ RS-232 IN Pins Instructions

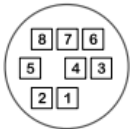

NO	Pins	Signals
1	DTR	Data Transmission Reade
2	DSR	Data Set Reade
3	TXD	Transmit Data
4	GND	Ground
5	RXD	Receive Data
6	GND	Ground
7	IR OUT	IR Commander Signal
8	N.C.	No Connection

▼ RS-232 OUT Pins Instructions

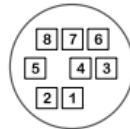

NO	Pins	Signals
1	DTR	Data Transmission Reade
2	DSR	Data Set Reade
3	TXD	Transmit Data
4	GND	Ground
5	RXD	Receive Data
6	GND	Ground
7	OPEN	Reserved
8	OPEN	Reserved

▼ RS-232 Connection Instructions

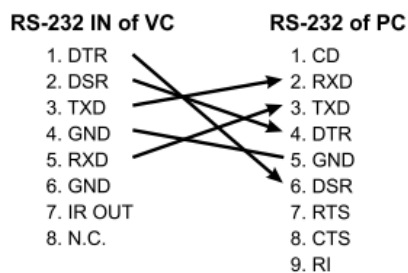

▼ RS-232 Connection Instructions

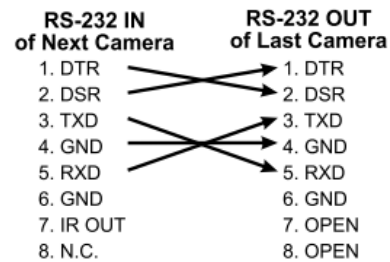

4.3.6 Connecting RS-422

Up to 7 Marshall cameras can be connected via RS422 daisy chain method.

When RS-422 connection is being used, keep RS-232 connections vacant.

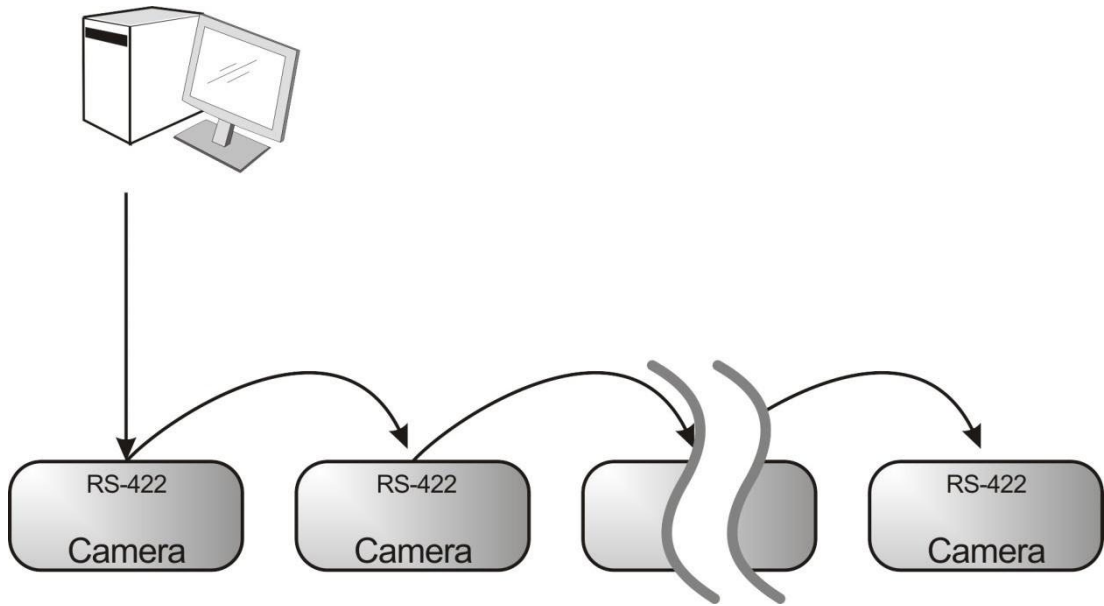

■ RS-422 pins definition instructions

▼ RS-422 Pins Instructions

Pin NO.	Function
1	RXD OUT-
2	RXD OUT+
3	TXD OUT-
4	TXD OUT+
5	GND
6	RXD IN-
7	RXD IN+
8	TXD IN-
9	TXD IN+

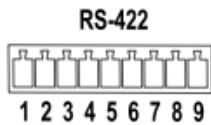

▼ RS-422 Serial Connection

Up to seven cameras can be daisy-chained

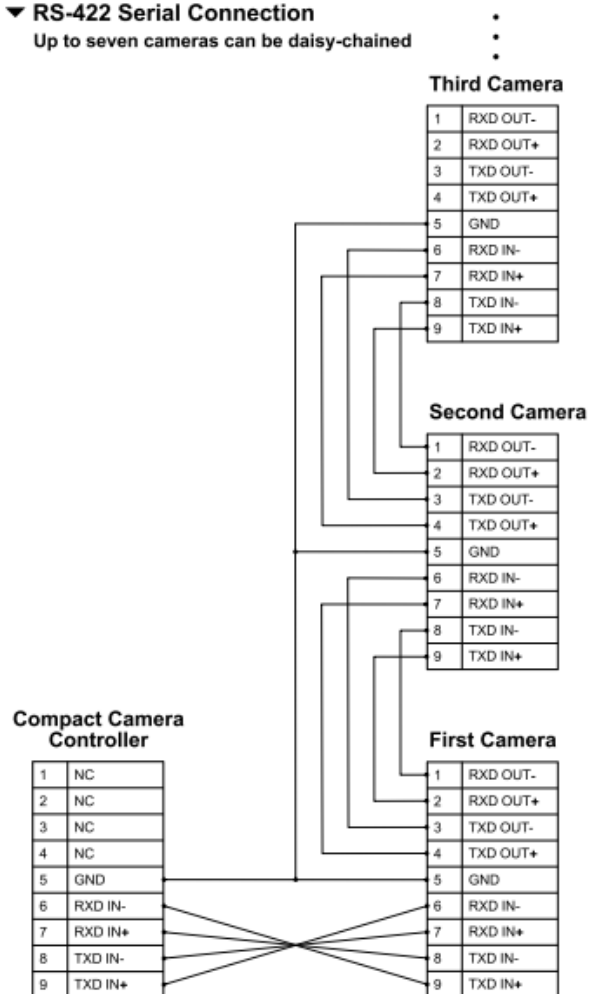

▼ RS-422 Connection Instructions

— Applicable to

Lumens Compact Camera Controller

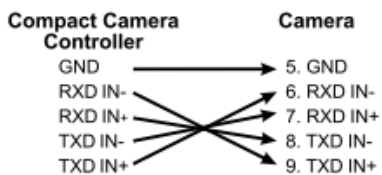

▼ RS-422 Connection Instructions

— Applicable to

SONY Compact Camera Controller

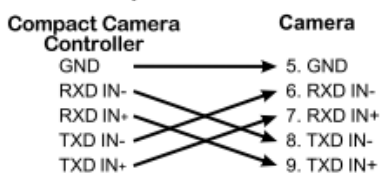

■ RS-422 connection instructions

1. Hold the two sides of RS-422 connector and pull out in the direction shown by the arrow in the figure below

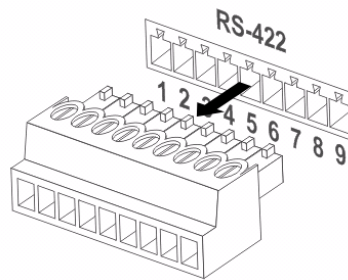

2. Peel off a section of copper wire (AWG Nos. 28 to 18) and insert it into the connector hole; then use flat screwdriver to tighten it into place.

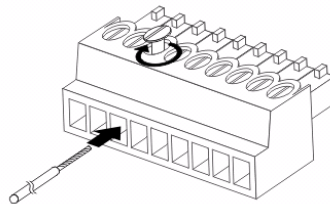

3. Insert the wired RS-422 connector back to the Camera. Now the connection is completed

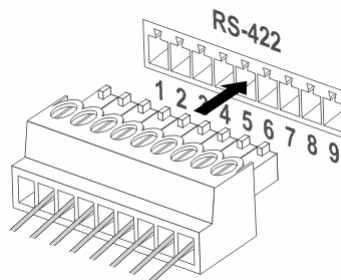

Chapter 5 Remote Control and Setting Menu

5.1 Functions of remote control

<Remark> The below functions are listed alphabetically.

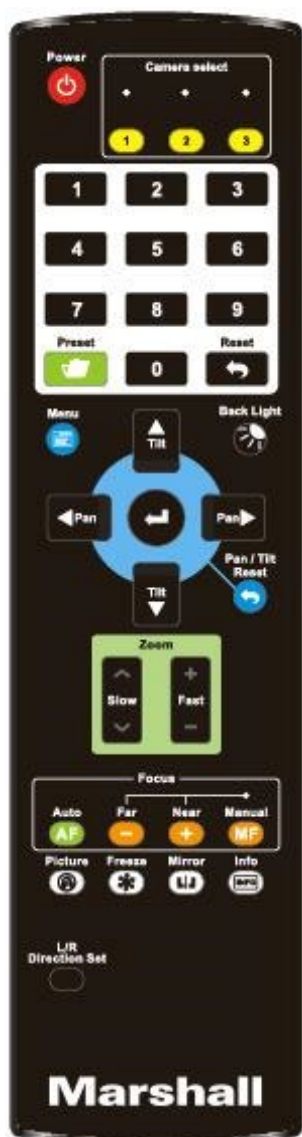

Item	Description
↓,→,←,↑	Move the lens
Back Light	Turn on/off back light compensation
Camera select	Choose Camera ID 1 ~ 3
Focus-Manual / Far/Near	Turn on manual focus to adjust the focal length
Focus-Auto	Auto Focus
Freeze	Freeze the image on screen
Home-Enter	Go back to the main page / Execute
Info	Status information
L/R Direction Set	L/R Direction / Normal
Menu	Display OSD menu
Mirror	Rotate the image (OFF / Mirror / Flip / Rotate)
Pan/Tilt Reset	Clear the Pan / Tilt setting
Picture	Switch image effect (OFF / Neg / B&W)
Power	Power Switch
Preset	Appoint an ID (0 ~ 9) to save the current position data
Reset	Appoint an ID (0 ~ 9) to delete the current position data
Zoom-Fast	Adjust image size
Zoom-Slow	Fine-tune image size

5.2 Setting Menu

<Remark> Press [**Menu**] on the **remote control** to enter the setting menu; the **bold underlined** values in the following table are defaults.

1st Level Major Items	2nd Level Minor Items	3rd Level Adjustment Values		Function Descriptions	
Exposure	Mode	1. <u>Full Auto</u> 2. Shutter Pri 3. Iris Pri 4. Manual		Exposure mode setting	
	Exposure Comp.	On / <u>Off</u>		AE Level	
	Exposure Comp. Level	-5 ~ <u>C</u> ~ 5		The value can be adjusted after Exposure Comp. is activated	
	Spot Light	On / <u>Off</u>			
	Spot Light Position	X (0 ~ 6) Y (0 ~ 4)		The value can be adjusted after Spot Light is activated	
	Shutter Pri		60/30 mode	50/25 mode	Adjustable when the Exposure mode is set to Shutter Pri
			1/10000	1/10000	
			1/5000	1/5000	
			1/3000	1/3000	
			1/2500	1/2500	
			1/2000	1/1750	
			1/1500	1/1250	
			1/1000	1/1000	
			1/725	1/600	
1/500			1/425		
1/350			1/300		
1/250			1/215		
1/180			1/150		
1/120	1/120				
1/100	1/100				
1/90	1/75				
<u>1/60</u>	<u>1/50</u>				
1/30	1/25				
1/15	1/12				
1/8	1/6				
1/4	1/3				
1/2	1/2				
1/1	1/1				
Iris Pri	1. F1.6 2. F2		Adjustable when the Exposure mode is set to		

		3. F2.2 4. F2.7 5. F3.2 6. F3.8 7. F4.5 8. F5.4 9. F6.3 10. F7.8 11. F9 12. F11 13. F13 14. F16 15. F18 16. Close	<i>Iris Pri</i>																																		
	Manual Gain	1. 0 dB 2. 3 dB 3. 6 dB 4. 9 dB 5. 12 dB 6. 15 dB 7. 18 dB 8. 21 dB 9. 24 dB 10. 27 dB 11. 30 dB 12. 33 dB 13. 36 dB 14. 39 dB 15. 42 dB 16. 45 dB	Adjustable when the Exposure mode is set to Manual																																		
	Manual Speed	<table border="1"> <tr> <td>60/30 mode</td> <td>50/25 mode</td> </tr> <tr> <td>1/10000</td> <td>1/10000</td> </tr> <tr> <td>1/5000</td> <td>1/5000</td> </tr> <tr> <td>1/3000</td> <td>1/3000</td> </tr> <tr> <td>1/2500</td> <td>1/2500</td> </tr> <tr> <td>1/2000</td> <td>1/1750</td> </tr> <tr> <td>1/1500</td> <td>1/1250</td> </tr> <tr> <td>1/1000</td> <td>1/1000</td> </tr> <tr> <td>1/725</td> <td>1/600</td> </tr> <tr> <td>1/500</td> <td>1/425</td> </tr> <tr> <td>1/350</td> <td>1/300</td> </tr> <tr> <td>1/250</td> <td>1/215</td> </tr> <tr> <td>1/180</td> <td>1/150</td> </tr> <tr> <td>1/120</td> <td>1/120</td> </tr> <tr> <td>1/100</td> <td>1/100</td> </tr> <tr> <td>1/90</td> <td>1/75</td> </tr> <tr> <td>1/60</td> <td>1/50</td> </tr> </table>	60/30 mode	50/25 mode	1/10000	1/10000	1/5000	1/5000	1/3000	1/3000	1/2500	1/2500	1/2000	1/1750	1/1500	1/1250	1/1000	1/1000	1/725	1/600	1/500	1/425	1/350	1/300	1/250	1/215	1/180	1/150	1/120	1/120	1/100	1/100	1/90	1/75	1/60	1/50	Manually set the shutter
60/30 mode	50/25 mode																																				
1/10000	1/10000																																				
1/5000	1/5000																																				
1/3000	1/3000																																				
1/2500	1/2500																																				
1/2000	1/1750																																				
1/1500	1/1250																																				
1/1000	1/1000																																				
1/725	1/600																																				
1/500	1/425																																				
1/350	1/300																																				
1/250	1/215																																				
1/180	1/150																																				
1/120	1/120																																				
1/100	1/100																																				
1/90	1/75																																				
1/60	1/50																																				

		1/30	1/25	
		1/15	1/12	
		1/8	1/6	
		1/4	1/3	
		1/2	1/2	
		1/1	1/1	
	Manual Iris	<ol style="list-style-type: none"> 1. F1.6 2. F2 3. F2.2 4. F2.7 5. <u>F3.2</u> 6. F3.8 7. F4.5 8. F5.4 9. F6.3 10. F7.8 11. F9 12. F11 13. F13 14. F16 15. F18 16. Close 		Manually set the iris
	Gain Limit	<ol style="list-style-type: none"> 1. 9 dB 2. 12 dB 3. 15 dB 4. 18 dB 5. 21 dB 6. 24 dB 7. <u>27 dB</u> 8. 30 dB 9. 33 dB 10. 36 dB 11. 39 dB 12. 42 dB 13. 45 dB 		Max. limit value of electron gain
	Iris Limit	<ol style="list-style-type: none"> 1. <u>F3.2</u> 2. F3.8 3. F4.5 4. F5.4 5. F6.3 6. F7.8 7. F9 8. F11 		Max. limit value of iris
	WDR	<ol style="list-style-type: none"> 1. <u>Off</u> 2. 1 3. 2 4. 3 		
White Balance	Mode	<ol style="list-style-type: none"> 1. <u>Auto</u> 2. Indoor 3. Outdoor 4. One Push WB 		Select the color temperature mode <ol style="list-style-type: none"> 1. 4000k ~ 7000k 2. 3200k

		5. ATW 6. Manual 7. Sodium Lamp	3. 5800k 4. 1700k ~ 10000k 5. 1700k ~ 10000k 6. Custom 7. 2800k
	One Push Trigger	<u>ENTER</u>	One push trigger
	Manual Red	0 ~ <u>C</u> ~ 128	Adjustable when the white balance mode is set to Manual
	Manual Blue	0 ~ <u>C</u> ~ 128	Adjustable when the white balance mode is set to Manual
Picture	Picture effect	1. <u>Off</u> 2. Neg 3. B & W	
	Sharpness	0 ~ <u>A</u> ~ 14	
	2D NR	1. Off 2. <u>1</u> 3. 2 4. 3	
	3D NR	1. Off 2. Low 3. <u>Typ</u> 4. Max	
	Image Mode	1. <u>Default</u> 2. Custom	The user may customize his/her desired image mode
	Image Mode Load	<u>ENTER</u>	Adjustable when the Image mode is set to Custom . After selected, the corresponding Image mode parameters will be read and applied to Custom
	Brightness	0 ~ <u>A</u> ~ 15	Adjustable when the Image mode is set to Custom
	Hue	0 ~ <u>A</u> ~ 15	Adjustable when the Image mode is set to Custom
	Saturation	0 ~ <u>A</u> ~ 15	Adjustable when the Image mode is set to Custom
	Gamma	0 ~ <u>A</u> ~ 3	Adjustable when the Image mode is set to Custom
Pan Tilt Zoom	Pan/Tilt Limit	On / <u>Off</u>	Turn on/off the angle limit setting
	Pan Right Limit	0 ~ <u>170</u>	Limit the right angle
	Pan Left Limit	<u>-170</u> ~ 0	Limit the left angle
	Tilt UP Limit	0 ~ <u>90</u>	Limit the upward angle

	Tilt Down Limit	-30 ~ 0	Limit the downward angle
	Pan Flip	On / <u>Off</u>	Activate the reverse Pan command
	Tilt Flip	On / <u>Off</u>	Activate the reverse Tilt command
	Preset Speed	<ol style="list-style-type: none"> 1. 5 deg/sec 2. 25 deg/sec 3. 50 deg/sec 4. 80 deg/sec 5. 120 deg/sec 6. <u>160 deg/sec</u> 7. 200 deg/sec 8. 300 deg/sec 	Set the rotation speed of the cradle head when Preset is executed
	PTZ Speed Comp	On / <u>Off</u>	Set the Pan/Tilt moving speed to vary from the zoom position
D-Effect	Mirror	<ol style="list-style-type: none"> 1. <u>Off</u> 2. Mirror 3. Flip 4. Mirror + Flip 	Set the mode at which the image is turned
Auto Focus	AF Sensitivity	<ol style="list-style-type: none"> 1. Low 2. <u>Middle</u> 3. High 	For AF triggering speed, the higher the speed is, the faster AF is triggered
	AF Frame	<ol style="list-style-type: none"> 1. Center 2. Full Frame 3. <u>Auto</u> 	AF frame setting, when central area was set as AF frame, focusing will be on the center of the screen. When Full Frame was set as AF frame, focusing will be calculated based on the full screen
	PTZ Assist	On / <u>Off</u>	Turn on the auto focus function in Manual
Ethernet	DHCP	<u>On</u> / Off	Enable/Disable DHCP setting using left and right arrow keys and press [ENTER] to apply setting.
	IP Address	<u>192.168.100.100</u>	Press [ENTER] to be in modify mode; select the item to be modified using the up and down keys, and modify the value using the left and right keys or the numeric keys.
	Subnet Mask	<u>255.255.255.0</u>	Press [ENTER] to be in modify mode; select the item to be modified using the up and down keys, and modify the value using the left and

			right keys or the numeric keys.
	Gateway	<u>192.168.100.254</u>	Press [ENTER] to be in modify mode; select the item to be modified using the up and down keys, and modify the value using the left and right keys or the numeric keys.
Audio	Audio In	<u>Line In</u> /Mic In	Set Audio In
	Audio Enable	On / <u>Off</u>	Turn on/off audio output
	Audio Volume	0 ~ <u>A</u> ~ 10	Volume Setting
	Encode Sample Rate	1. <u>48 KHz (AAC)</u> 2. 44.1 KHz (AAC) 3. 16 KHz (G.711) 4. 8 KHz (G.711)	Set the encode type and sample rate SDI supports the audio output of 48 KHz only
System	Prompt	On / <u>Off</u>	Turn on/off the prompt information on the display
	IR Receive	<u>On</u> / Off	
	Tally Lamp	<u>Enable</u> / Disable	
	Language	<u>English</u> / Chinese	
	Initial Position	<u>Last MEM</u> / 1st Preset	Set the camera lens to return to the last operated position or the first preset position after POWER ON
	Control Device	Encoder / <u>Controller</u>	Control Device setting, Controller: for joystick Encoder: for tracking system
	Motionless Preset	On / <u>Off</u>	When the function is enabled, the screen will Freeze when Preset is executed. Freeze will be released after Preset is completed.
	Control Port	<u>RS-232</u> /RS-422	Choose whether the control interface used is RS-232 or RS-422
	Protocol	<u>VISCA</u> /Pelco D	
	Baud Rate	<u>9600</u> /38400	Choose the transmission speed of the control signal
	VISCA Address	<u>0</u> ~ 7	
	Pelco D Address	<u>1</u> ~ 255	The Protocol set to Pelco D allows the camera ID address to be assigned

	Output Mode	<ol style="list-style-type: none"> 1. 3840 x 2160/29.97p 2. 3840 x 2160/25p 3. <u>1080p/59.94</u> 4. 1080p/50 5. 1080p/29.97 6. 1080p/25 7. 720p/59.94 8. 720p/50 9. 720p/29.97 10. 720p/25 	Choose the output resolution
	Factory Reset	On / <u>Off</u>	Resume the factory default setting
Status			Display the current setting status

Chapter 6 Network Function Settings Description

6.1 Connecting Camera to IP Network

6.1.1 Connecting to Internet

Two common connection methods are shown below

1. Connecting via switch or router



2. To connect directly through network cable, the IP address of the computer should be changed so that it is on the same network segment as the camera
e.g.: The factory-preset default IP address of CV630-IP is 192.168.100.100. The computer IP address must be set with the same network segment, such as 192.168.100.101, so that the computer can be connected correctly with the camera

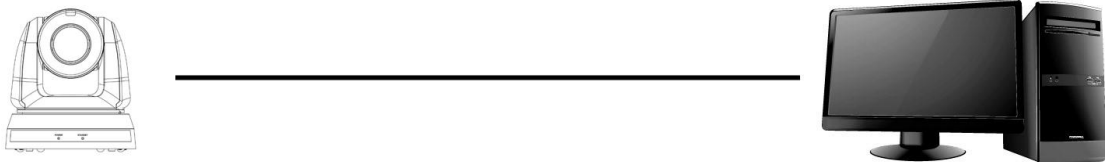

- Change network settings

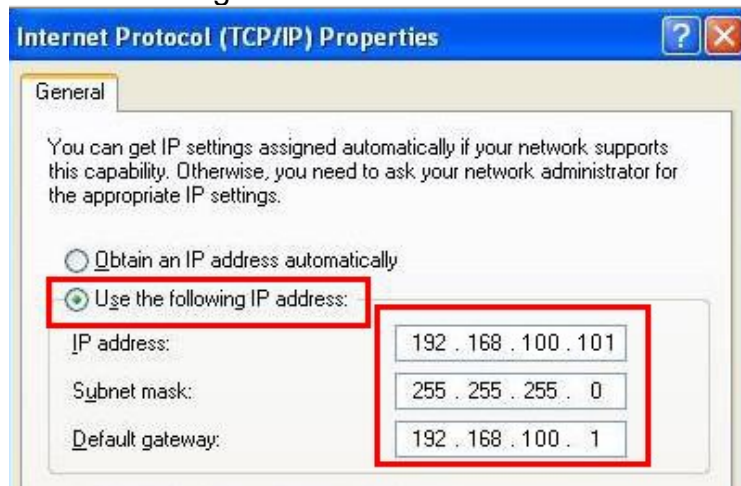

6.1.2 Using the Browser to View the Images

- Open the browser, and enter the URL of CV630-IP in the IP address bar e.g.: <http://192.168.100.100> (default IP address)
- Enter administrator's account and password

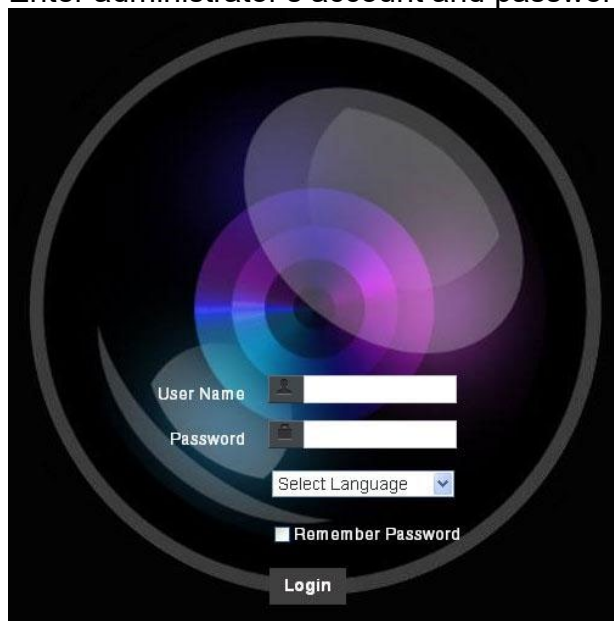

Marshall IP Camera
| Account: admin
| Password: 9999

6.1.3 Using Marshall VMS Software to View the Images

- Open **MARSHALL VMS** software
 - Search for the camera: Press  [automatically search for the device] button to locate the CV630-IP camera
 - Click CV630-IP in the list and start operation after connecting to network
- <Note> When using automatic search, the camera and computer must be in the same network segment, e.g.: 192.168.4.X**

6.1.4 Using RTSP Player to View the Images

In addition to the software GUI in internet browser and VMS, other free software also can be used for RTSP connections, such as VLC, Quick Time and PotPlayer
RTSP connection address formats are as follows:

- RTSP Main Streaming => <rtsp://camera IP:8554/hevc>
- RTSP Sub1 Streaming => <rtsp://camera IP:8557/h264>
- RTSP Sub2 Streaming => <rtsp://camera IP:8556/h264>

Example: Open VLC software and enter URL: <rtsp://192.168.100.150:8557/h264>

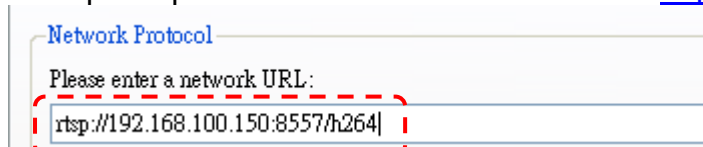

6.2 Web Page Function Description

6.2.1 Login Screen

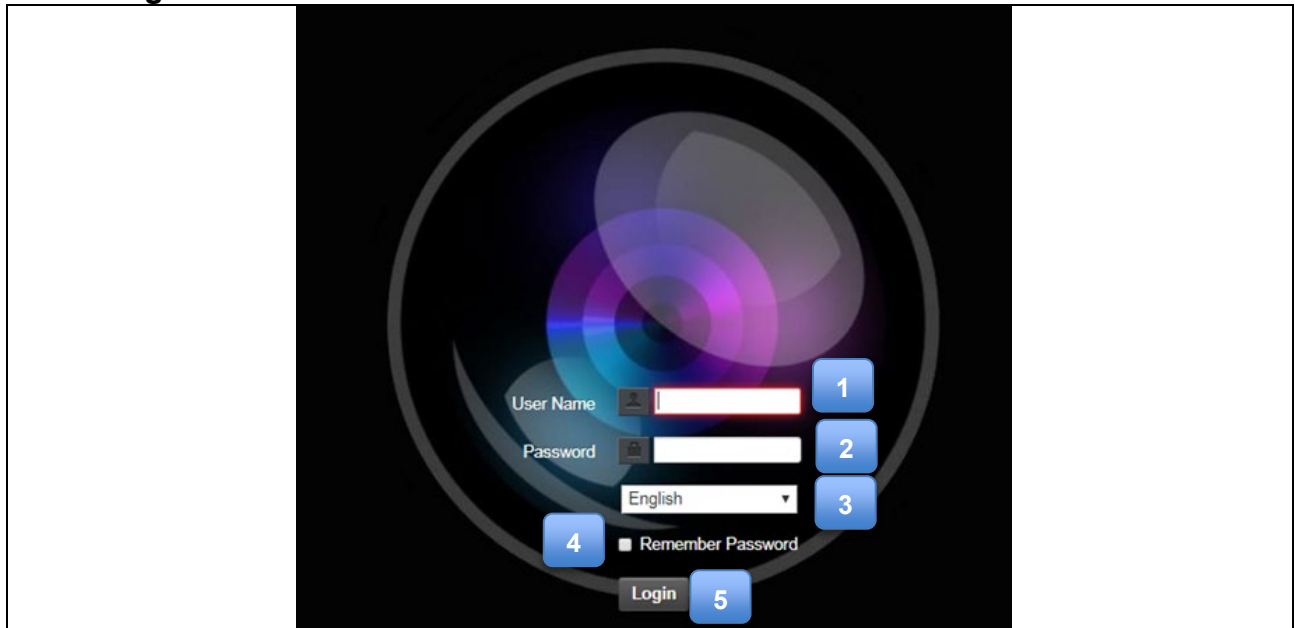

No	Item	Function Descriptions
1	Username	Enter user account (default: admin)
2	Password	Enter user password (default: 9999)
3	Language selection	Currently, the system supports English, Traditional Chinese and Simplified Chinese
4	Remember password	Save user account name and password to the browser. When you log in next time, there is no need to re-enter them
5	Login	Log into the administrator screen on the website

6.2.2 Viewing In Real Time

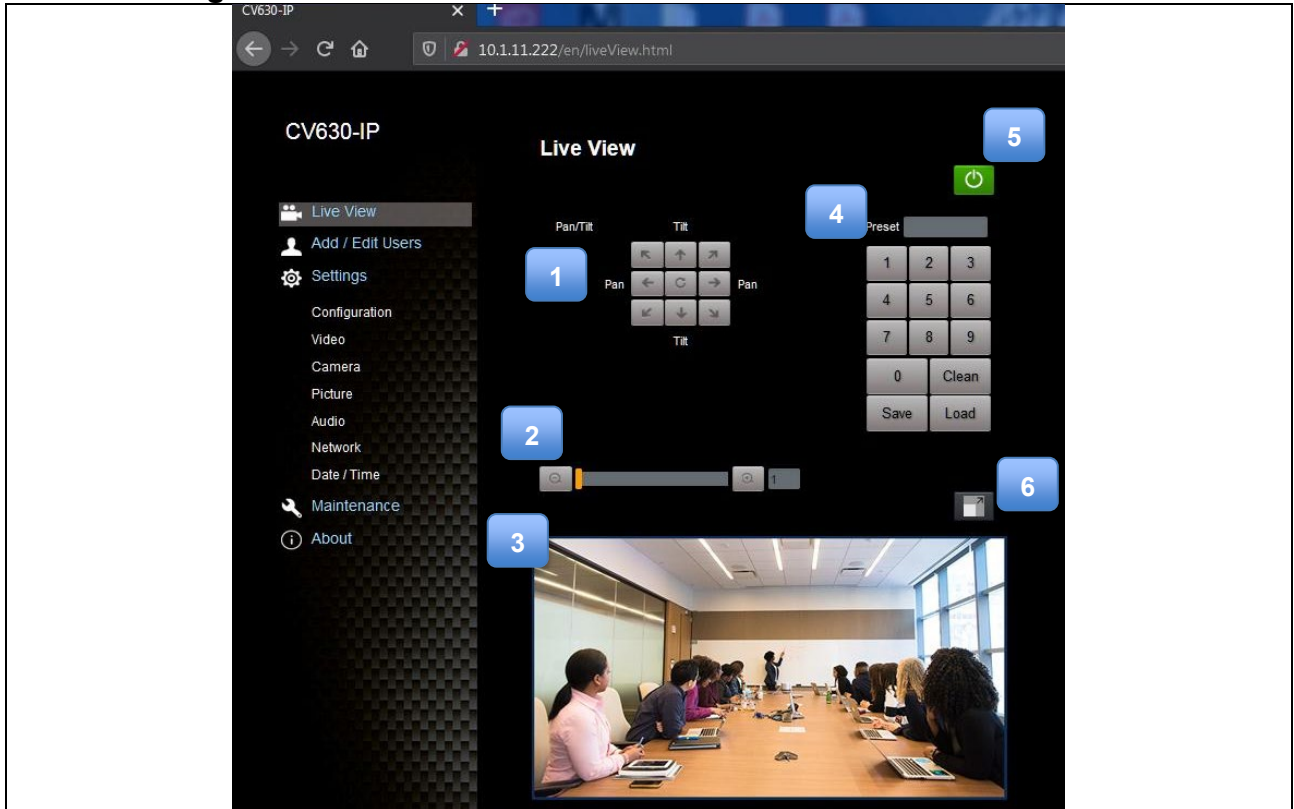

No	Item	Function Descriptions
1	Pan / Tilt setting	Adjust the Pan/Tilt position of the camera screen
2	Zoom ratio	Adjust the zoom-in or zoom-out ratio via scroll bar
3	Preview window	Display the screen currently captured by the camera
4	Preset setting	Select the number first and then select SAVE or LOAD
5	Power button	Turn on or turn off the camera power
6	Switch to Full Screen	Switch the preview window to full screen

6.2.3 Account Management



No	Item	Function Descriptions
1	Add user account	Enter a user name and password to add a new user

2	Permission setting	Set the new account management permissions			
		User Type	Admin	Operator	Viewer
		View images	V	V	V
		Settings	V	V	X
	Account management	V	X	X	
3	Applying setting	Add the newly created user to the list of account			
4	List of accounts	Edit: Modify the user password and permissions Delete: Delete the user account			

6.2.4 Setting-System Setting

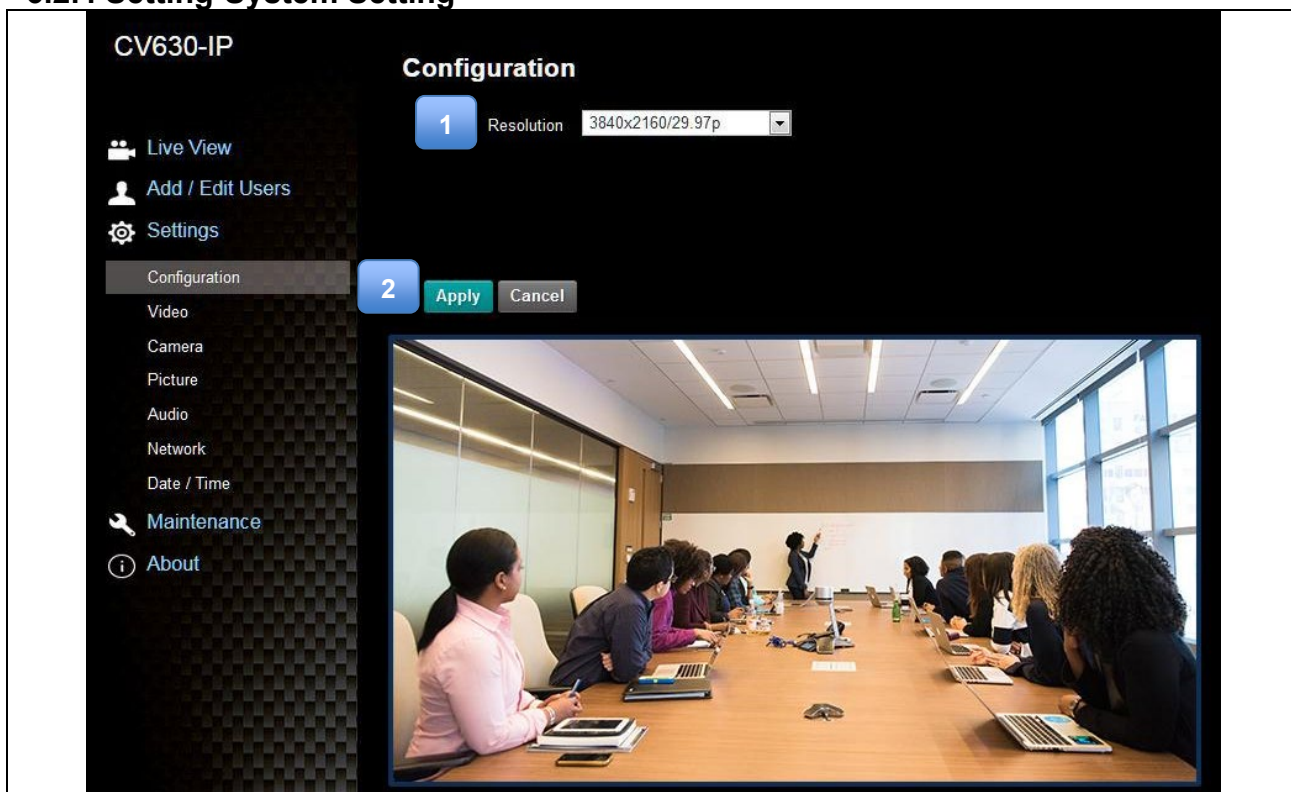

No	Item	Function Descriptions
1	Resolution	Set the resolution of the camera, resolutions supported by the camera are as follows: 3840 x 2160 29.97/25 fps 1080P 59.94/50/29.97/25 fps 720P 59.94/50/29.97/25 fps After switching to the resolution, the camera will restart. Please refresh the browser
2	Apply	After the setting has been modified, select this button to apply the setting

6.2.5 Setting - Video

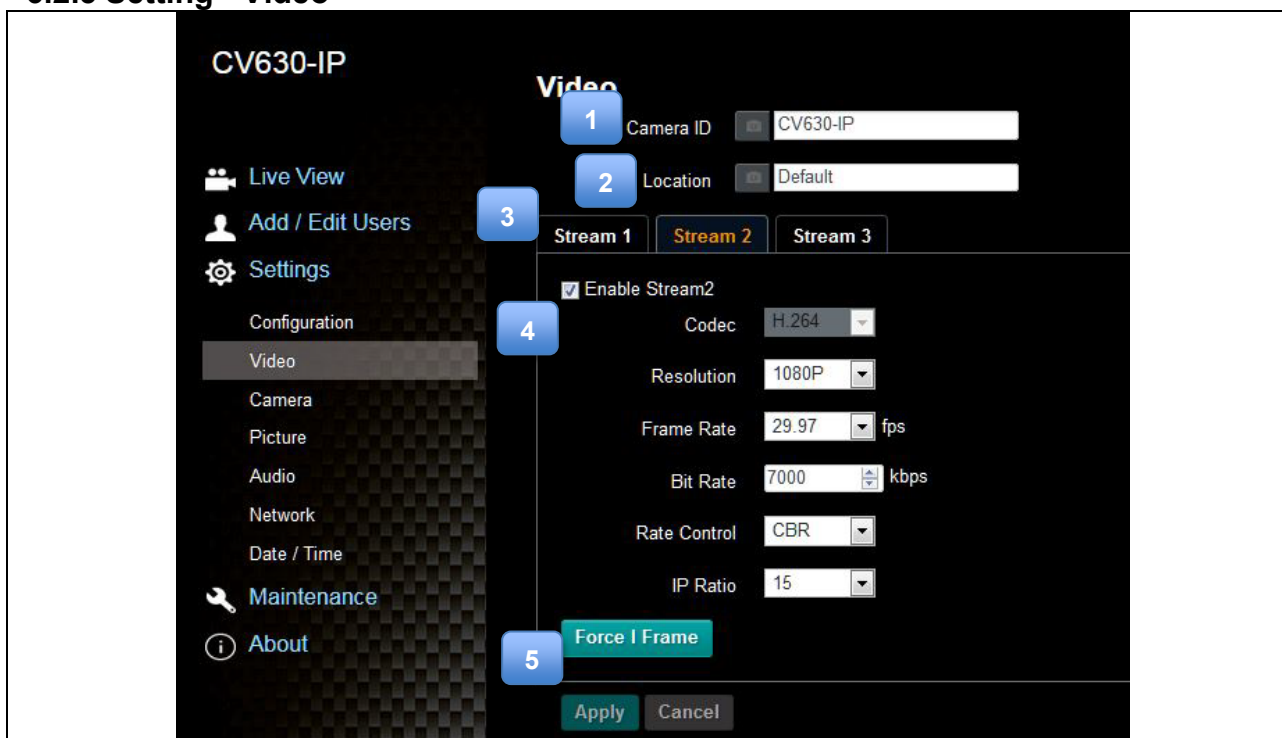

No	Item	Function Descriptions
1	Camera name	<p>Modify the camera name</p> <ul style="list-style-type: none"> Camera names are limited to 1 - 12 characters Please use a camera name by mixing uppercase and lowercase letters or numbers. Do not use "/" and "space" or special symbols
2	Camera Location	<p>Modify the location of the camera, such as Meeting Room 1</p> <ul style="list-style-type: none"> Camera location is limited to 1 - 12 characters Please use a camera name by mixing uppercase and lowercase letters or numbers. Do not use "/" and "space" or special symbols
3	Streaming 1/ Streaming 2/ Streaming 3	CV630-IP supports 3 streaming outputs. Please refer to 6.2.5.1 Streaming Parameter Setting for relevant settings
4	Open Streaming	Confirm whether or not the streaming function is opened
5	Force I Frame	Check this item to insert IDR frame into specified series flow and apply its setting. User's setting will be reserved and displayed in GUI interface

6.2.5.1 Streaming parameter setting

Function		Streaming 1	Streaming 2	Streaming 3
Encode Format		H.265	H.264	
Resolution		4K /1080P / 720P	1080P/720P	640 x 360
Frame Rate		Setting according to the supported resolution		
Bit Rate (kbps)	Range	2,000 ~ 20,000	2,000 ~ 20,000	512 ~ 5,000
	Factory Default	7,000	7,000	1,000
Rate Control		CBR/VBR		
IP Ratio		Setting according to the supported resolution		

6.2.6 Setting - Camera



No	Item	Function Descriptions
1	Zoom ratio	Adjust the zoom-in or zoom-out ratio via scroll bar
2	Exposure	<ul style="list-style-type: none"> ■ Mode: Select exposure mode (Automatic/Shutter Priority/Aperture Priority/Manual) ■ Exposure Comp. Level: Select exposure compensation level ■ Gain: The gain limit is adjustable when the exposure mode is set to "Manual" ■ Iris: The size of aperture is adjustable when the exposure mode is set to "Manual" or "Aperture Priority" ■ WDR: Set the level of wide dynamic range (WDR) in order to obtain better images ■ Shutter Speed: The shutter speed is adjustable when the exposure mode is set to "Manual" or "Shutter Priority"
3	White Balance	<ul style="list-style-type: none"> ■ Mode: Select the color temperature mode <ul style="list-style-type: none"> ➢ Auto ➢ Indoor ➢ Outdoor ➢ One Push WB ➢ ATW ➢ Manual ➢ Sodium Lamp ■ One Push WB: One push color temperature is adjustable when the white balance mode is set to "One Push WB" ■ Manual Red/Blue: Manually adjust blue/red color temperature
4	Focus	<ul style="list-style-type: none"> ■ Mode: Select manual/automatic focus ■ Focus Range: The focusing range is adjustable when the focus mode is set to "Manual" ■ AF Sensitivity: Set automatic focus sensitivity ■ AF Frame: Set automatic focus range

5	Mirror	■ Mirror: Set automatic flip mode
---	--------	--

6.2.7 Setting - Picture

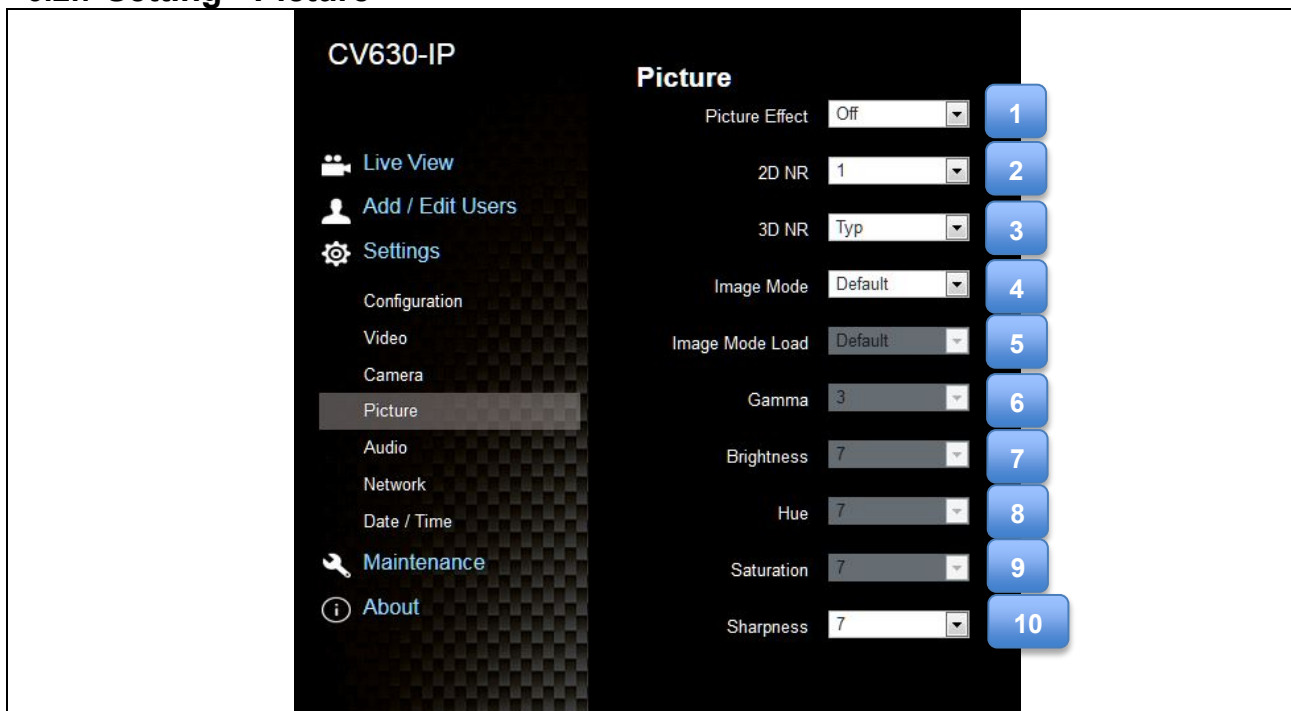

No	Item	Function Descriptions
1	Picture Effect	Set picture effect, Off/Neg/Black and White
2	2D noise reduction settings	2D noise reduction settings
3	3D noise reduction settings	3D noise reduction settings
4	Image mode	The user may customize his/her desired image mode
5	Image Mode Load	When no custom setting is needed, reset the picture parameters back to the factory default by selecting this item
6	Gamma	Gamma Level adjustment; Adjustable when the image mode is set to Custom
7	Brightness	Brightness adjustment; Adjustable when the image mode is set to Custom
8	Contrast	Contrast adjustment; Adjustable when the image mode is set to Custom
9	Saturation	Saturation adjustment of the image; Adjustable when the image mode is set to Custom
10	Sharpness	Adjust the sharpness of the image

6.2.8 Setting - Audio

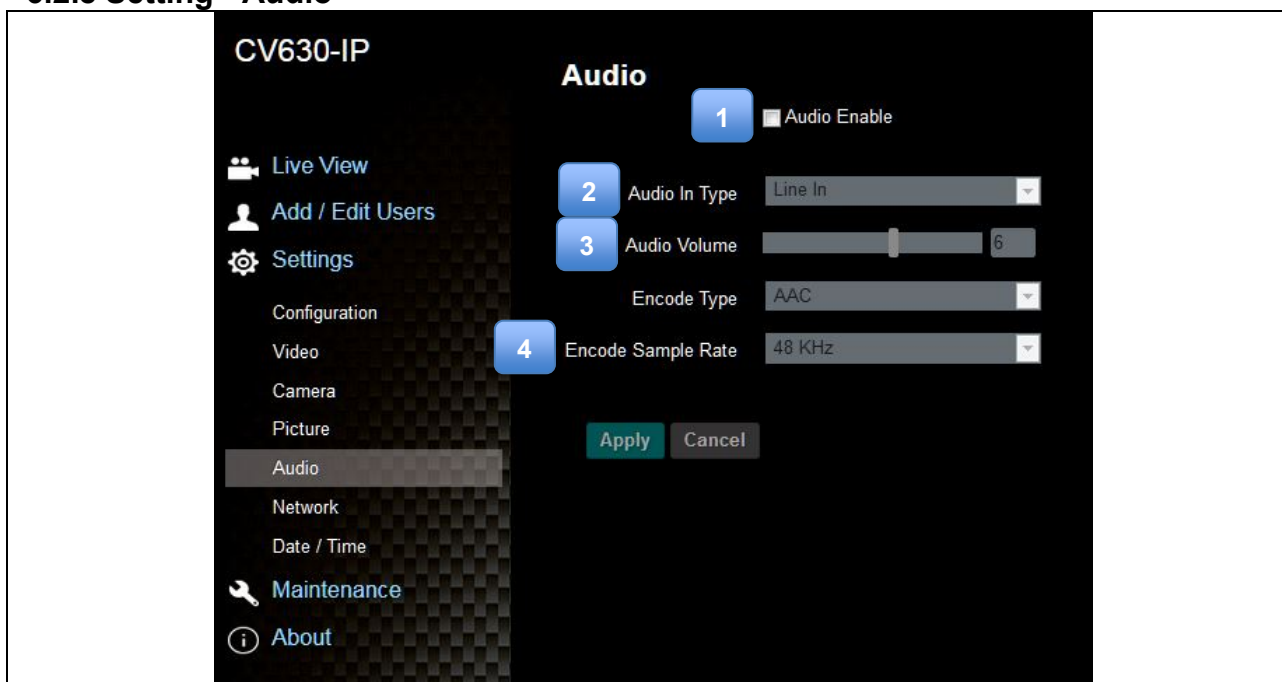

No	Item	Function Descriptions
1	Open audio	Turn on/off sound
2	Soundtrack effect setting	Set MIC In/Line In
3	Volume	Adjust Volume
4	Encode sample rate	Set Encode sample rate ➤ 48 KHz (AAC) ➤ 44.1 KHz (AAC) ➤ 16 KHz (G.711) ➤ 8 KHz (G.711)

6.2.9 Setting - Network

No	Item	Function Descriptions
1	Network	Network setting of camera. Change of setting is available when DHCP function is closed.
2	RTMP Setting	Copy the RTMP web address provided by the RTMP service platform and paste it to the RTMP connection address to publish the camera images on the RTMP service platform To upload to YouTube for live streaming, the audio function must be turned on first
3	RTSP Setting	Enable/Disable Multicast. It is suggested to enable Multicast when the number of users online watching the live image simultaneously is more than 4
4	MPEG-TS Setting	Set MPEG-TS format <Remark> The following port has been used by the camera. Setting of the port may not connect correctly 8554, 8556, 8557, 8080, 80, 81, 9090, 23
5	SNTP Setting	Set SNTP Server IP
6	Port Setting	Set HTTP port. The default Port value is 80 <Remark> Change of setting is available only when DHCP function of camera is closed

6.2.10 Setting-Time

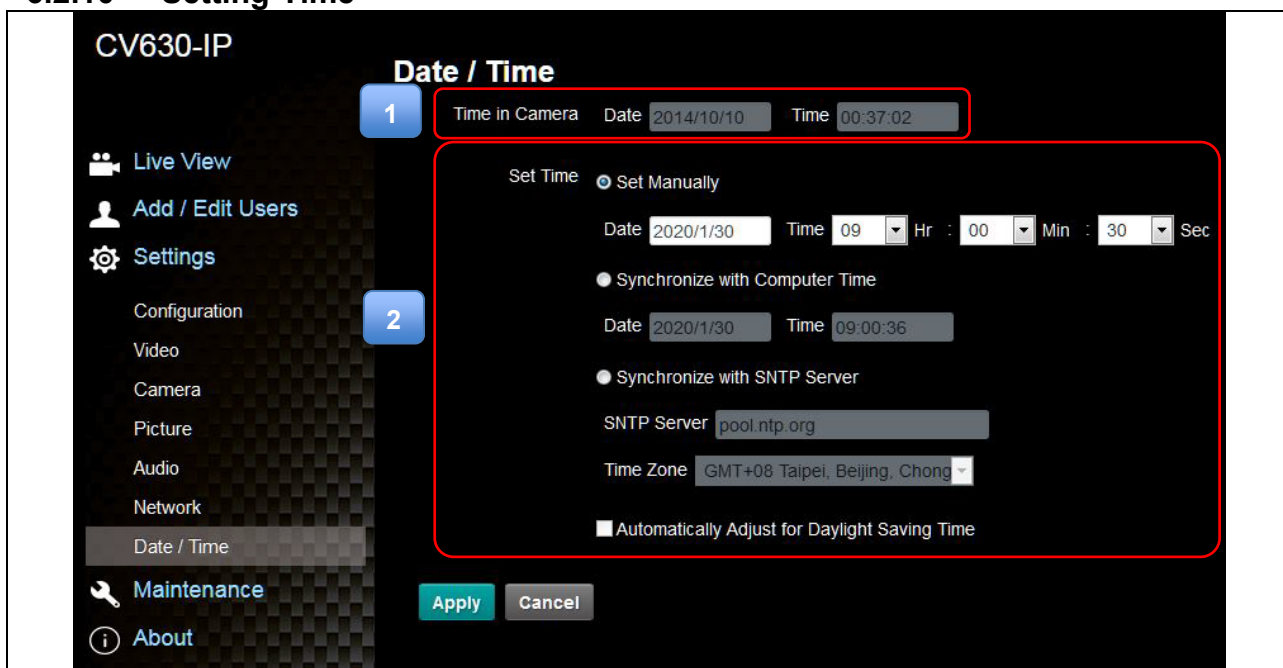

No	Item	Function Descriptions
1	Camera Time	Display the date and time of the camera
2	Set the Time	<ul style="list-style-type: none"> ■ Manually: Set time manually ■ Synchronize with computer time: Set the camera time according to the computer time ■ Synchronize with SNTP server: Set the camera time synchronously with the SNTP server <p><Remark> SNTP server address: Please change in network setting</p>

6.2.11 Setting - Maintenance - Upgrading Firmware

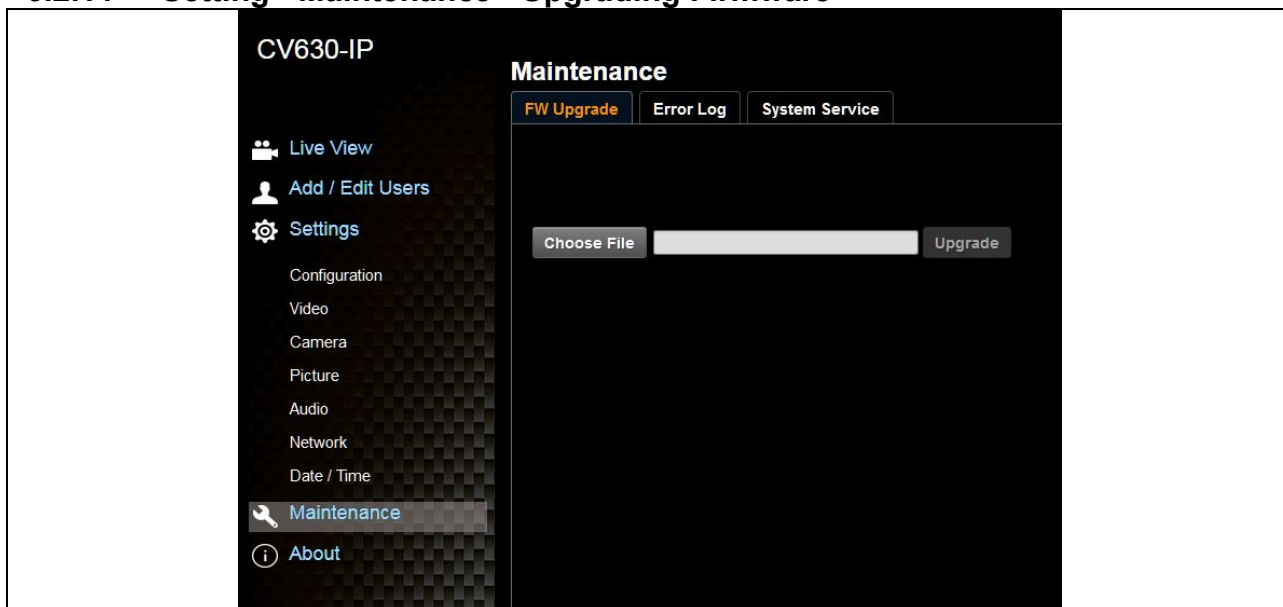

No	Item	Function Descriptions
1	Firmware Update	The camera firmware may be upgraded via web page. For the upgrade method, please download the FW upgrade manual from Marshall official website

6.2.12 Maintenance - Incident Log

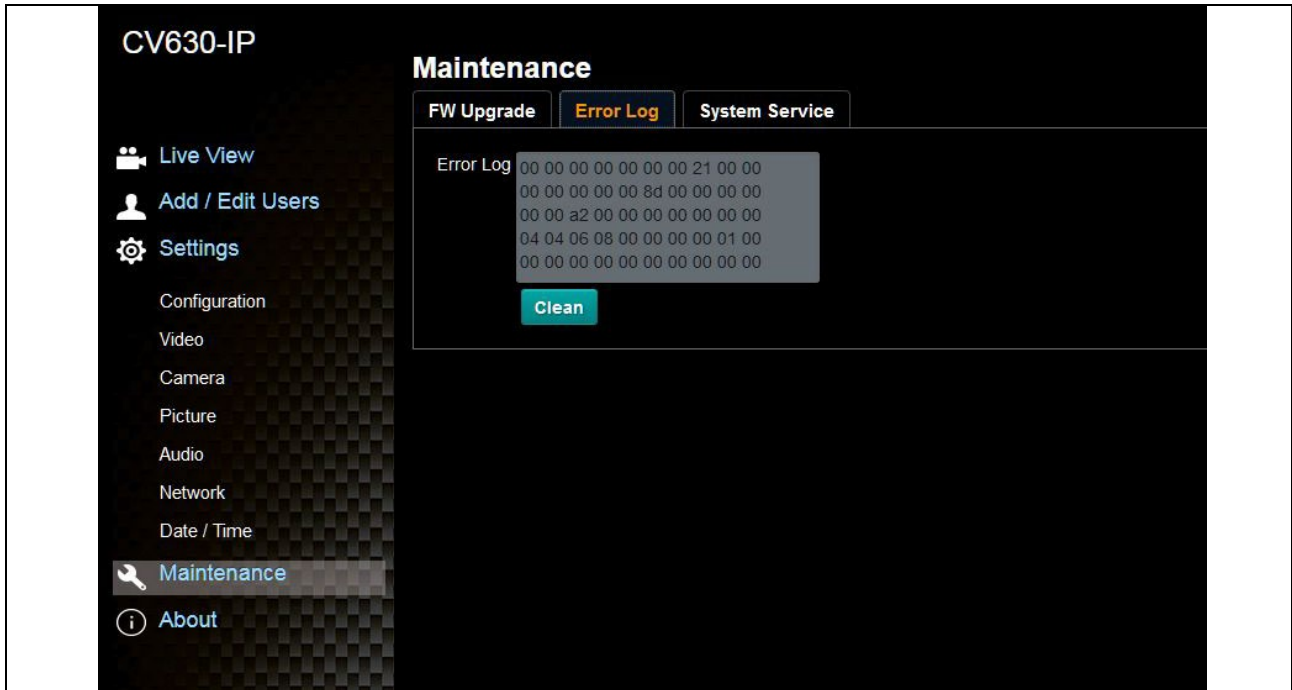

No	Item	Function Descriptions
1	Event Logs	If the camera encounters errors, an error code log will be established

6.2.13 Setting - Maintenance - System Service

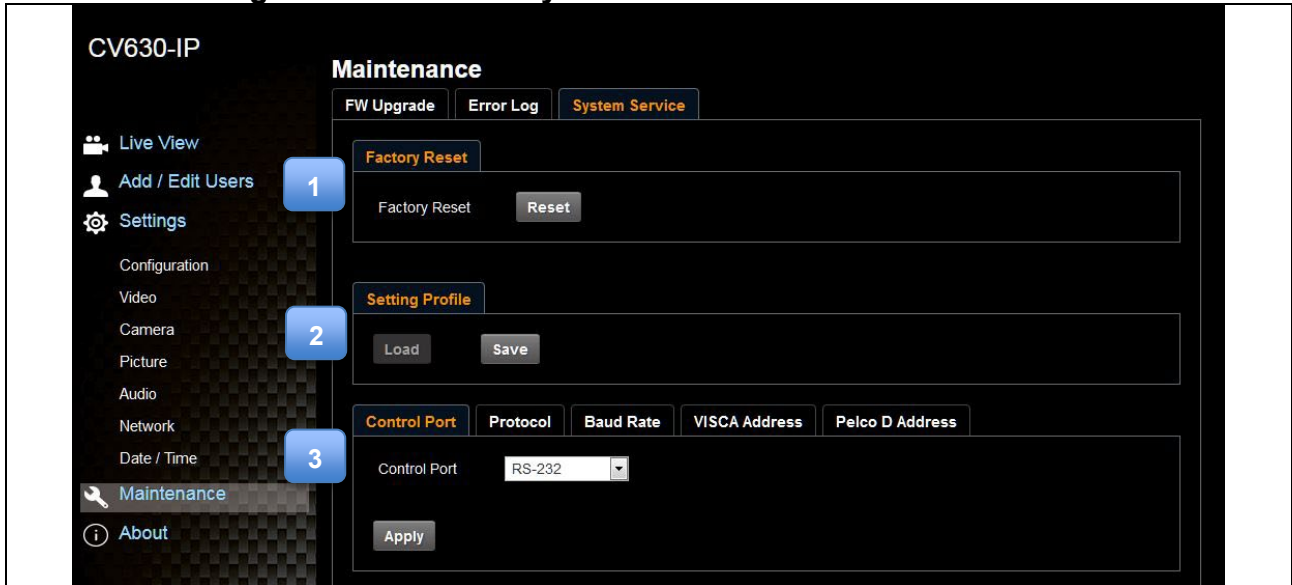

No	Item	Function Descriptions
1	Reset to the default value	Select the reset button to resume the factory default setting as the web page setting
2	Setting File	The web page setting parameters can be exported from the computer and imported/applied to another camera
3	Baud Rate	Set the camera Baud Rate for the use of connecting RS-232 communication

6.2.14 About

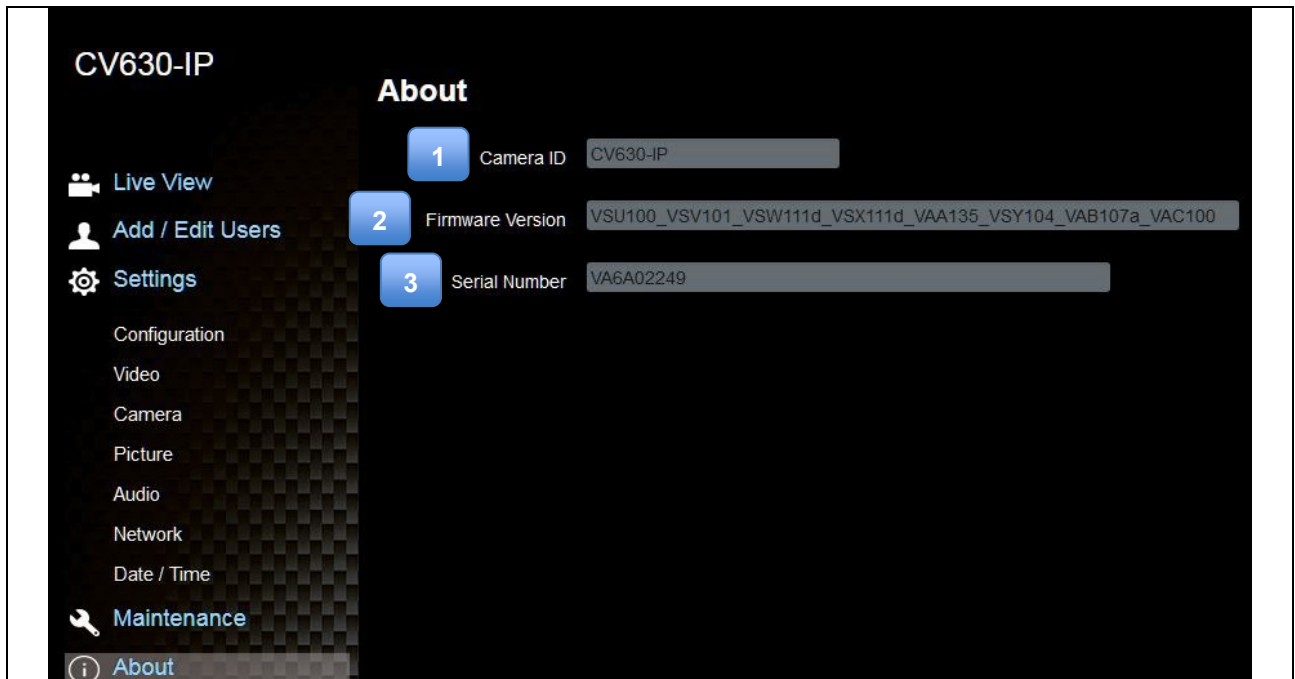

The screenshot shows the 'About' page for a CV630-IP camera. The page is dark-themed with white text. On the left is a sidebar with navigation icons and labels: Live View, Add / Edit Users, Settings, and Maintenance. The 'About' option is highlighted at the bottom of the sidebar. The main content area is titled 'About' and displays three items, each with a blue numbered callout (1, 2, 3) pointing to the label. The items are: Camera ID (CV630-IP), Firmware Version (VSU100_VSV101_VSW111d_VSX111d_VAA135_VSY104_VAB107a_VAC100), and Serial Number (VA6A02249).

No	Item	Function Descriptions
1	Camera name	Display the camera name
2	Firmware Version	Display the firmware version of the camera
3	Serial No.	Display the camera serial No.

Chapter 7 DIP Switch Setting

7.1 DIP SWITCH

7.1.1 OUTPUT Switch

To switch via the OSD/ RS-232 Command is also available based on the last executed action



ID	Resolution	Frame Rate
0	3840 x 2160	29.97
1		25
2	1920 x 1080	59.94
3		50
4		29.97
5	1280 x 720	25
6		59.94
7		50
8		29.97
9	25	
A	Reserved	Reserved
B		
C		
D		
E		
F		

7.1.2 IR SELECT



ID	Setting
1	<input checked="" type="checkbox"/>
2	<input type="checkbox"/>
3	<input type="checkbox"/>

Chapter 8 Troubleshooting

This chapter describes problems you may encounter while using CV630-IP. If you have questions, please refer to related chapters and follow all the suggested solutions. If the problem still occurred, please contact your distributor or Marshall IP technical support.

No.	Problems	Solutions
1.	Boot without power signal	<ol style="list-style-type: none">1. Make sure you have plugged in the power cord.2. When using a PoE connection, ensure that the power supply supports POE+ (IEEE 802.3at) hubs
2.	There is no image output from CV630-IP	<ol style="list-style-type: none">1. Check the power supply or PoE supply functions.2. Confirm the output signals are in streaming output.3. Confirm whether the camera resolution can be used together with the monitor equipment<ul style="list-style-type: none">■ If 4k output, confirm the monitor equipment supports 4K output4. Replace the cables and make sure they are not faulty.
3.	CV630-IP image is severely delayed	Please use 1080p or 720p 60/50 fps rather than 25/30 fps signals.
4.	RS-232 cannot be controlled	<ol style="list-style-type: none">1. Confirm the connection is correct (RS-232 In/ Out)2. Please make sure the Baud rate setting is the same as the control equipment
5.	Whether the Internet can be used for operation	Please refer to Chapter 6 Network Function Description for the Internet usage